



THE BEAUTY OF WATER.
THE SCIENCE OF RENEWAL.

2017 Catalog



8.2021



nuwhirl.com
951 817 5600

22520 Temescal Canyon Rd, Ste B
Corona, CA 92883

Rethink. Refresh. Renew.
Call us today!

951.817.5600
sales@nuwhirl.com

or learn more at NuWhirl.com

REV 8.26.2021

CMP Bath Acquisition Info



NuWhirl Systems Corp and Custom Molded Products (CMP) announced on July 16, 2021 a definitive agreement under which NuWhirl acquired CMP's bath product lines, strengthening the company's position as the top supplier of jetted and luxury bath components.

The two companies have worked together for years in complimentary business arrangements. CMP has long supplied NuWhirl with ozone sanitizer systems, and following the acquisition, NuWhirl will continue as CMP's ozone supplier to the bath industry.

Consumer response to COVID-19 and international shortages in raw materials have led to a surge in demand for spa, pool, and bath components. CMP's sale of its bath lines will give the company greater capacity to serve customers in the pool and spa sectors. Through the arrangement, NuWhirl has added CMP's products to its variety of bath jets, air systems, pumps, heaters, and accessories. The deal has expanded NuWhirl's injection molding capabilities and plastic white good product line, and the company will purchase more than 50 tools and systems from CMP to produce them.

Products sold under the CMP brand prior to July 16, 2021 are honored under its warranty, terms, and conditions. Products sold on or after July 16, 2021 are branded under the NuWhirl name and honored under its warranty, terms, and conditions.

THIS 2017 CMP BATH CATALOG DOCUMENT IS PROVIDED FOR REFERENCE AND ARCHIVAL PURPOSES ONLY. SOME PRODUCT CONTAINED HEREIN INCLUDING BUT NOT LIMITED TO NEXUS ELECTRONIC CONTROLS MAY NOT BE AVAILABLE FOR PURCHASE UNDER NUWHIRL. FOR THE LATEST INFORMATION ON CMP BATH PRODUCT INFORMATION, PLEASE CONTACT NUWHIRL SALES AT SALES@NUWHIRL.COM OR CONTACT YOUR SALES REPRESENTATIVE.

CMP BATH
PRODUCTS

2017

TABLE OF CONTENTS

Welcome 4

CMP Bath Brands 5

Catalog Information 6

Color Reference 7

BATH JET COLLECTIONS 9

SÔL SERIES JETS 10

TECH SERIES JETS 17

ECON SERIES JET 22

BATH SERIES JETS 28

MINI JETS 32

CARESSE® SYSTEM 38

BATH EQUIPMENT 41

NEXXUS CONTROLS 42

NEXXUS PUMPS 54

NEXXUS DH HEATERS 58

NEXXUS AIR BLOWERS 59

CONTROL VALVES & BUTTONS 61

AIR CONTROLS 62

TOP MOUNT VALVES 66

SIDE MOUNT VALVES 67

WHITE GOODS 69

SUCTIONS 70

FITTINGS 74

UNIONS & CHECK VALVES 75

BATH MANIFOLDS 76

FLEX HOSE & TUBING 77

BATH ACCESSORIES 79

BATHTUB FEET 80

SHOWER ACCESSORIES 81

AROMA & CHROMATHERAPY 82

ADA GRAB BARS & SHOWER SEATS 84

SHOWER CURTAINS 85

Part Number Index 88

Terms & Conditions 91

CMP Limited Warranty 92



WELCOME

**CMP 2017 BATH
PRODUCTS CATALOG****SENIOR EDITOR**

Victor Walker

SENIOR EDITOR

JIM RAMSEY

DESIGN & CONTENT EDITOR

Stephen Boswell

ENGINEERING ADVISOR

Zack Vogtner

PRODUCT EDITOR

ALISON BRIGHT

PROJECT ASSISTANT

Susie Cuebas

The CMP Bath Products Catalog is a team project that included CMP Marketing, Engineering, Sales and Customer Service. Thank you to the entire team and to each individual that has contributed to the 2017 CMP Bath Products Catalog.

- EVERYTHING MATTERS®

©2017 CMP, LLC
All rights reserved

The bath is one of the most personal things in any home. That's why CMP works to provide suites of products to help OEMs create that personal bathing experience. Nexus™ controls create a custom simplified experience. Caresse® turns a bath into a soothing escape. SÖL™ designs disappear into the tub with a comfortable, flush finish. At CMP we are committed to continually working with you to provide the personal experience your customers want. Because when the difference in the details, everything matters.



WHAT'S NEW FOR 2017

CMP is proud to introduce the complete Nexus bath control system. The new, modern system features flexible control systems, solenoid operation, capacitive touch controls and simple LCD interfaces. (Page 41)



Nexus

SÖL BATH COLLECTION

SÖL Bath is a European-inspired "flush" bath collection from CMP. The SÖL designs and forms are simple, elegant and graceful. The complete collection included bath jets, topside controls and suctions.

SOL COLLECTION: PAGE 10



The patent-pending design of Caresse® creates a soothing style of water therapy using the unique vented jet design. Caresse® gently wraps your body in ribbons of warm water.

Caresse® SYSTEM: PAGE 38

Nexxus™

CMP now offers a complete system of electronic components for bath. The Nexxus brand includes digital controllers, pumps, heaters and blowers. Equipment is available for U.S. and International markets.

NEXXUS EQUIPMENT: PAGE 41

The CMP logo, division "lockup" and tagline everything matters® are registered trademarks of Custom Molded Products,LLC. All CMP Bath Products logos and trademarks are property of CMP. SOL™, Caresse® and Nexxus™ are trademarks and/or registered trademarks of CMP.

The absence of a trademark, trade name or service mark from the above list does not constitute a waiver of our intellectual property rights concerning that trademark, trade name or service mark. All custom graphics, icons, logos and words listed above are trade names, trademarks or service marks of Custom Molded Products in the United States and/or other countries.

The trademarks and names of other companies and products mentioned herein are the property of their respective owners.

CATALOG INFORMATION

ABBREVIATION GUIDE

S = SOCKET

SB = SMOOTH BARB

WP = WHIRLPOOL

SP = SPIGOT

SS = STAINLESS STEEL

P/N = PART NUMBER

WTR = WATER

ASSY = ASSEMBLY

G. GRAY = GRAPHITE GRAY

RB = RIBBED BARB

GPM = GALLONS PER MINUTE

BOX AND BAG QUANTITIES

Box Quantities are listed for most items. If a bag quantity is also available, it will be indicated as "box/bag," such as "24/6" where "24" is the box quantity and "6" is the bag quantity.

Currently CMP does not apply a surcharge for broken carton orders. Please help us maintain this policy by ordering in full carton quantities. **Thank you for your cooperation.**

FOR MORE INFORMATION

Terms & Conditions pg 91

CMP Limited Warranty pg 162

All illustrations, photographs, product details and specifications in this catalog are current as of available information at the time of printing.

To access the digital version of this catalog, you may view or download online at www.c-m-p.com/catalog.



*Indicates CMP New
for 2017 Products*

THANK YOU FOR USING THE 2017 CMP BATH PRODUCTS CATALOG













COLOR REFERENCE

The standard CMP numbering scheme for designating the color of plastic products is indicated within the part number as follows:

A B C D E - F G H - I J K

EXAMPLE: 23500-010-000 (10 = BRIGHT WHITE)

Always specify the product color by both name and number when placing orders to reduce errors.

					WHITE: SERIES 0 00 - White 10 - Bright White 20 - Medium White 30 - Oyster 40 - Classic White
					BONE: SERIES 5 15 - Bone 25 - Biscuit 35 - Almond
					BRASS: SERIES 3 03 - Polished Brass 23 - Oil Rubbed Bronze Aged*
					NICKEL: SERIES 8 08 - Brushed Nickel 28 - Polished Nickel CHROME: SERIES 2 02 - Polished Chrome

CUSTOM COLORS

Additional colors are available upon request. Custom colors can be provided. Please call for details. A minimum order will be required.

FITTINGS

Unless otherwise specified fitting bodies and other underskirt components are molded in white or gray.

SPECIAL ORDER *

Product colors marked with an asterisk are non-stock special order only.



BATH JET COLLECTIONS

SÖL™ SERIES JETS 10

TECH SERIES JETS 17

ECON SERIES JET 22

BATH SERIES JETS 28

MINI JETS 31

CARESSE® SYSTEM 36

SÖL

BATH COLLECTION

Introducing the *SÖL Bath Collection*, a European-inspired bath collection from CMP. The SÖL designs and forms are simple, elegant and graceful. A classic contemporary overtone allows SÖL to complement any bath design and decor. The complete SÖL Bath Collection includes suctions, lights, and controls for a total style package.



LUXURY PERFORMANCE

CONTEMPORARY STYLE

CLASSIC DESIGNS



SÖL BATH JETS

SERIES THREE

PRODUCT FEATURES

- Adjustable Flow Control
- Directional Nozzle
- Silicone Injection Ports
- 3.5" Round Face
- "L" or "V" Jet Body



2-3/4"/69.8mm Hole Size
3/8" Air x 26mm Water



ORDERING GUIDE

REF	CMP P/N	DESCRIPTION	BOX QTY
SÖL SERIES THREE			
A	24601-002-000	SERIES THREE DIRECTIONAL & FLOW ADJUSTABLE INTERNAL	30
B	24600-000-200	SERIES THREE ROTATIONAL INTERNAL	30
C	24601-002-030	SERIES THREE WALL FITTING/TRIM RING	30
D	24601-002-040	SERIES THREE FLUSH ESCUTCHEON	30
E	24601-000-001	SERIES THREE GASKET	30
F	24600-000-010	SERIES THREE "V" JET BODY WITH CHECK VALVE	30
G	24600-000-020	SERIES THREE "L" JET BODY WITH CHECK VALVE	30
—	24601-999-999	JET TOOL FOR WALL FITTING	—

SÖL BATH JETS

SERIES TWO: DECO NON-ADJUSTABLE

PRODUCT FEATURES

- Stylish "Deco" Ring Design
- Silicone Injection Ports
- "V" or "L" or Body
- 2" Round Face
- Directional Nozzle



1-11/16" / 42.4mm Hole Size
 3/8" SB Air
 26mm or 1" Water

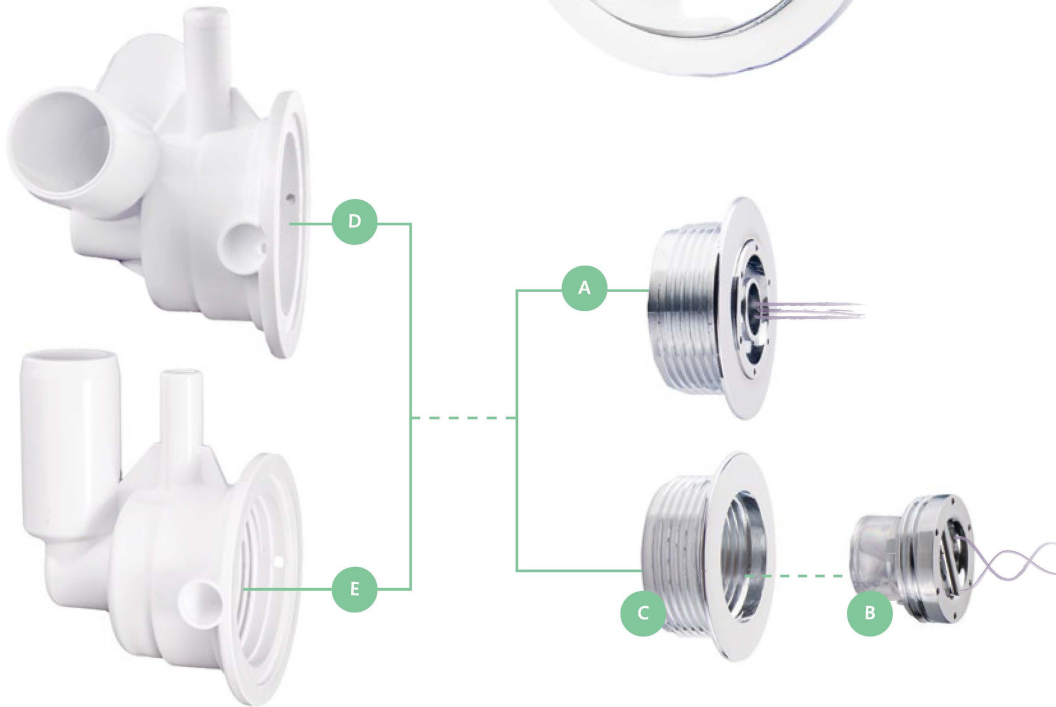

ORDERING GUIDE

REF	CMP P/N	DESCRIPTION	BOX QTY
SÖL SERIES TWO DECO NON-ADJUSTABLE			
A	24100-000-600	SERIES TWO DECO DIRECTIONAL NOZZLE & WALL FITTING ASSEMBLY, WHITE	50
A	24100-012-600	SERIES TWO DECO DIRECTIONAL NOZZLE & WALL FITTING ASSEMBLY, CHROME	50
B	24100-000-700	SERIES TWO DECO ROTO NOZZLE, WHITE	50
B	24100-002-700	SERIES TWO DECO ROTO NOZZLE, CHROME	50
C	24100-000-603	SERIES TWO DECO WALL FITTING, WHITE	100
C	24100-002-603	SERIES TWO DECO WALL FITTING, CHROME	100
D	24001-000-600	SERIES TWO DECO 26MM V-BODY (NON FLOW-ADJUSTABLE)	250
D	24101-000-600	SERIES TWO DECO 1" V-BODY (NON FLOW-ADJUSTABLE)	250
E	24101-000-620	SERIES TWO DECO 1" L-BODY (NON FLOW-ADJUSTABLE)	100
E	24001-000-620	SERIES TWO DECO 26MM L-BODY (NON FLOW-ADJUSTABLE)	100
—	24100-000-999	SERIES TWO WALL FITTING TOOL	—

SÖL BATH JETS

SERIES TWO: DECO ADJUSTABLE

PRODUCT FEATURES

- Stylish "Deco" Ring Design
- Silicone Injection Ports
- 2" Round Face
- "V" or "L" or Body
- Adjustable Flow
- Directional Nozzle

 1-11/16" / 42.4mm Hole Size
 3/8" SB Air
 26mm or 1" Water

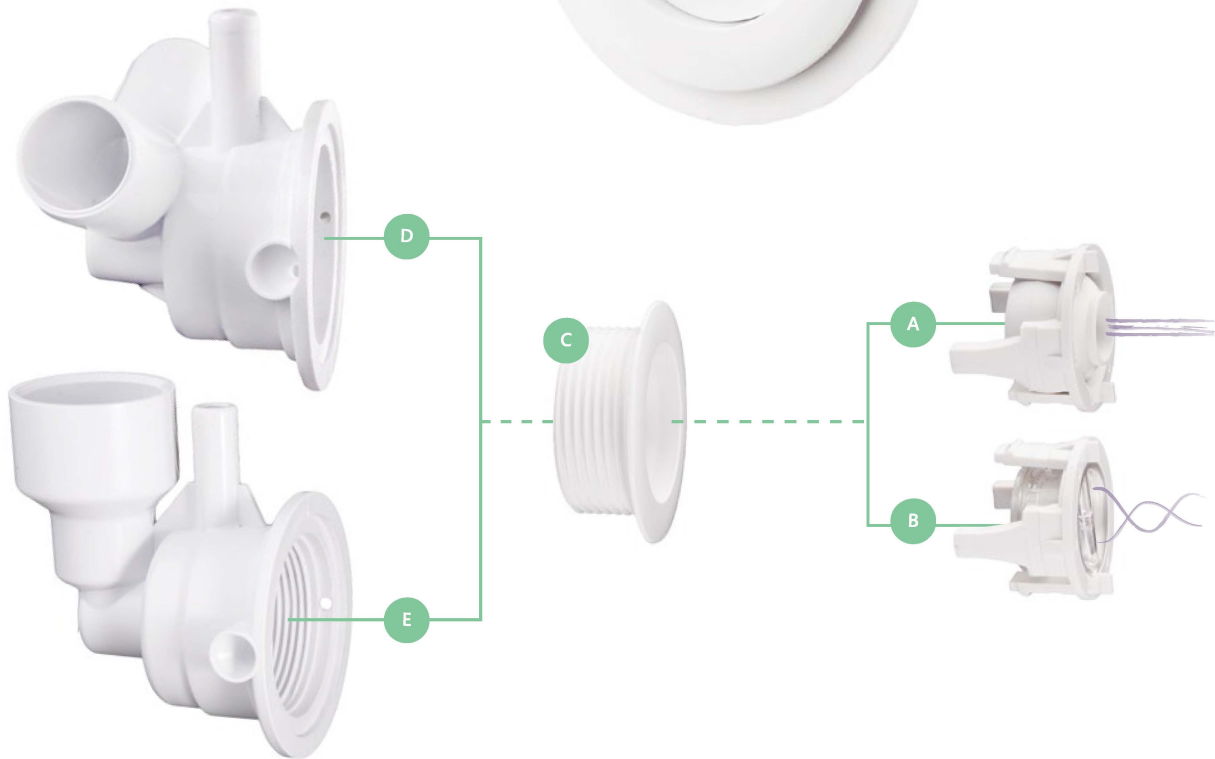

ORDERING GUIDE

REF	CMP P/N	DESCRIPTION	BOX QTY
SÖL SERIES TWO DECO ADJUSTABLE			
A	24100-000-900	SERIES TWO DECO ADJUSTABLE DIRECTIONAL NOZZLE INTERNAL, WHITE	50
B	24100-000-910	SERIES TWO DECO ADJUSTABLE ROTO NOZZLE INTERNAL, WHITE	50
C	24100-000-090	SERIES TWO DECO ADJUSTABLE JET WALL FITTING	100
D	24000-000-200	SERIES TWO 26MM ADJUSTABLE V-BODY	250
D	24100-000-200	SERIES TWO 1" ADJUSTABLE V-BODY	100
E	24100-000-220	SERIES TWO 1" ADJUSTABLE L-BODY	100
E	24000-000-220	SERIES TWO 26MM ADJUSTABLE L-BODY	100
—	24100-000-999	SERIES TWO WALL FITTING TOOL	—

SÖL BATH JETS

SERIES TWO: SMOOTH

PRODUCT FEATURES

- Adjustable Flow
- Smooth Face Design
- 2" Round Face
- Directional Flow
- Silicone Injection Ports
- "V" or "L" or Body

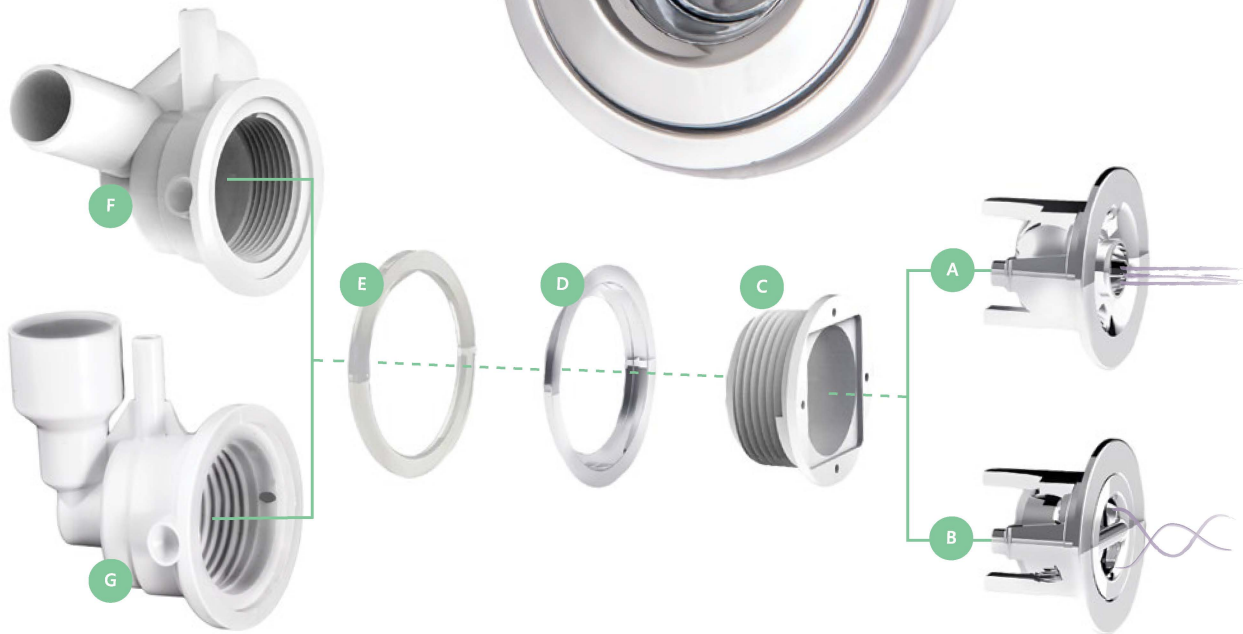
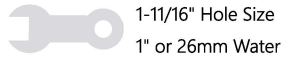

ORDERING GUIDE

REF	CMP P/N	DESCRIPTION	BOX QTY
SÖL SERIES TWO SMOOTH			
A	24100-500-000	SERIES TWO SMOOTH DIRECTIONAL JET INTERNAL	50
B	24100-500-100	SERIES TWO SMOOTH ROTO JET INTERNAL	50
C	24100-500-040	SERIES TWO SMOOTH WALL FITTING	100
D	24100-500-030	SERIES TWO SMOOTH WALL FITTING ESCUTCHEON (STAINLESS STEEL RING)	50
E	24100-500-070	SERIES TWO WALL FITTING GASKET	50
F	24000-000-200	SERIES TWO 26MM ADJUSTABLE V-BODY	250
—	24000-000-300	SERIES TWO 26MM ADJUSTABLE V-BODY WITH EXTENDED FLANGE	—
—	24000-000-305	SERIES TWO 26MM ADJUSTABLE V-BODY W/ EXTENDED FLANGE & CHECK VALVE	—
F	24100-000-200	SERIES TWO 1" ADJUSTABLE V-BODY	100
G	24000-000-220	SERIES TWO 26MM ADJUSTABLE L-BODY	100
—	24000-000-320	SERIES TWO 26MM ADJUSTABLE L-BODY WITH EXTENDED FLANGE	—
—	24000-000-325	SERIES TWO 26MM ADJUSTABLE L-BODY W/ EXTENDED FLANGE & CHECK VALVE	—
G	24100-000-220	SERIES TWO 1" ADJUSTABLE L-BODY	100
—	24100-999-999	WALL FITTING TOOL (100-E)	—

SÖL BATH JETS

SERIES TWO: SLOTTED

PRODUCT FEATURES

- Unique Slotted Jet
- Smooth Face Design
- Silicone Injection Ports
- "V" or "L" or Body
- Adjustable or Non-Adjustable Flow



1-11/16"/42.4mm Hole Size

3/8" SB Air

1" or 26mm Water

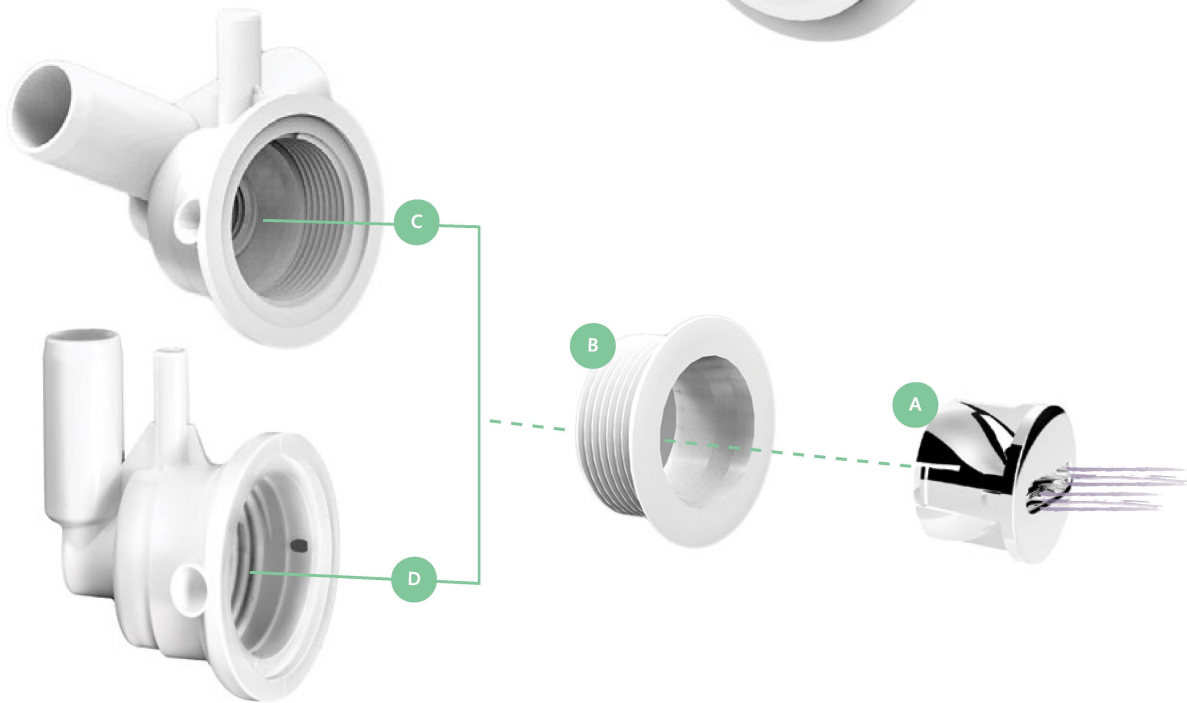

ORDERING GUIDE

REF	CMP P/N	DESCRIPTION	BOX QTY
SÖL SERIES TWO SLOTTED			
A	24100-000-094	SERIES TWO SLOTTED JET INTERNAL	50
B	24100-000-090	SERIES TWO SLOTTED WALL FITTING	100
C	24100-000-200	SERIES TWO 1" ADJUSTABLE V-BODY	100
C	24101-000-700	SERIES TWO SLOTTED 1" NON-ADJUSTABLE V-BODY	100
C	24000-000-200	SERIES TWO 26MM ADJUSTABLE V-BODY	250
C	24001-000-700	SERIES TWO SLOTTED 26MM NON-ADJUSTABLE V-BODY	100
D	24100-000-220	SERIES TWO 1" ADJUSTABLE L-BODY	100
D	24101-000-720	SERIES TWO SLOTTED 1" NON-ADJUSTABLE L-BODY	100
D	24000-000-220	SERIES TWO 26MM ADJUSTABLE L-BODY	100
D	24001-000-720	SERIES TWO SLOTTED 26MM NON-ADJUSTABLE L-BODY	100
—	24100-000-999	WALL FITTING TOOL	—

SÖL BATH JETS

MICRO SERIES

PRODUCT FEATURES

- Silicone Injection Ports
- "V" or "L" Body
- Uni-Directional or Roto Internal
- Flow Adjustable or Non-Adjustable Internals



1-1/2"/38.1mm Hole Size
 3/8" SB Air
 26mm or 3/4" Water

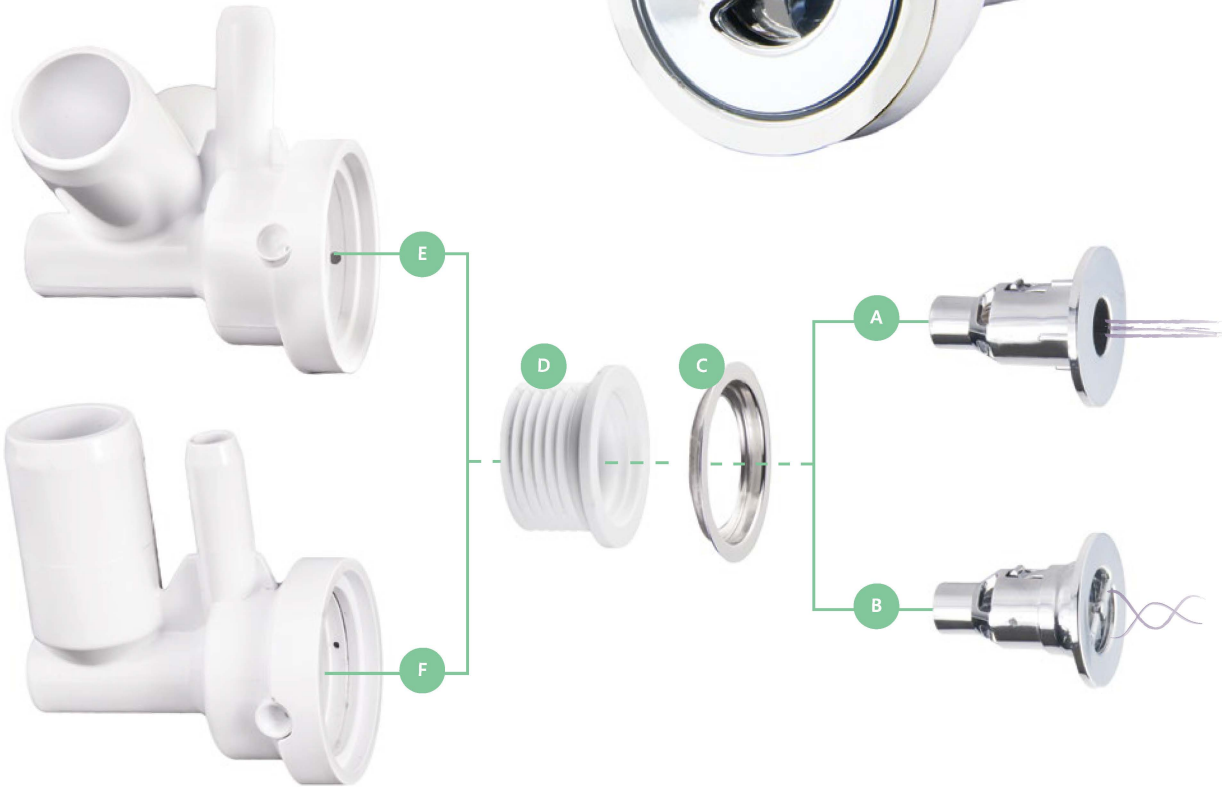

ORDERING GUIDE

REF	CMP P/N	DESCRIPTION*	BOX QTY
SÖL MICRO SERIES			
A	23400-800-100	1.25" MICRO FIXED JET INTERNAL, ADJUSTABLE	50
A	23400-800-000	1.25" MICRO FIXED JET INTERNAL, NON-ADJUSTABLE	50
B	23401-800-100	1.25" MICRO FIXED ROTO JET INTERNAL, ADJUSTABLE	50
B	23401-800-000	1.25" MICRO FIXED ROTO JET INTERNAL, NON-ADJUSTABLE	50
C	23400-800-010	1.25" MICRO ESCUTCHEON/TRIM RING	50
D	23400-840-040	1.25" MICRO WALL FITTING	100
E	23400-800-030	1.25" MICRO 26MM V-BODY WITH ADAPTER WITH CHECK VALVE	100
F	23400-900-080	1.25" MICRO 26MM L-JET BODY WITH ADAPTER WITH CHECK VALVE	100
F	23400-950-080	1.25" MICRO 3/4 SOCKET L-BODY WITH ADAPTER WITH CHECK VALVE	100
—	23400-999-999	TOOL FOR MICRO WALL FITTING	—

TECH SERIES JETS

TS-I JET

PRODUCT FEATURES

- Smooth Rounded Face
- Flow Control Nozzle
- Directional Nozzle
- Silicone Injection Ports
- "V" or "L" Jet Body



2-3/8" Hole Size
3/8" SB Air
26mm Water

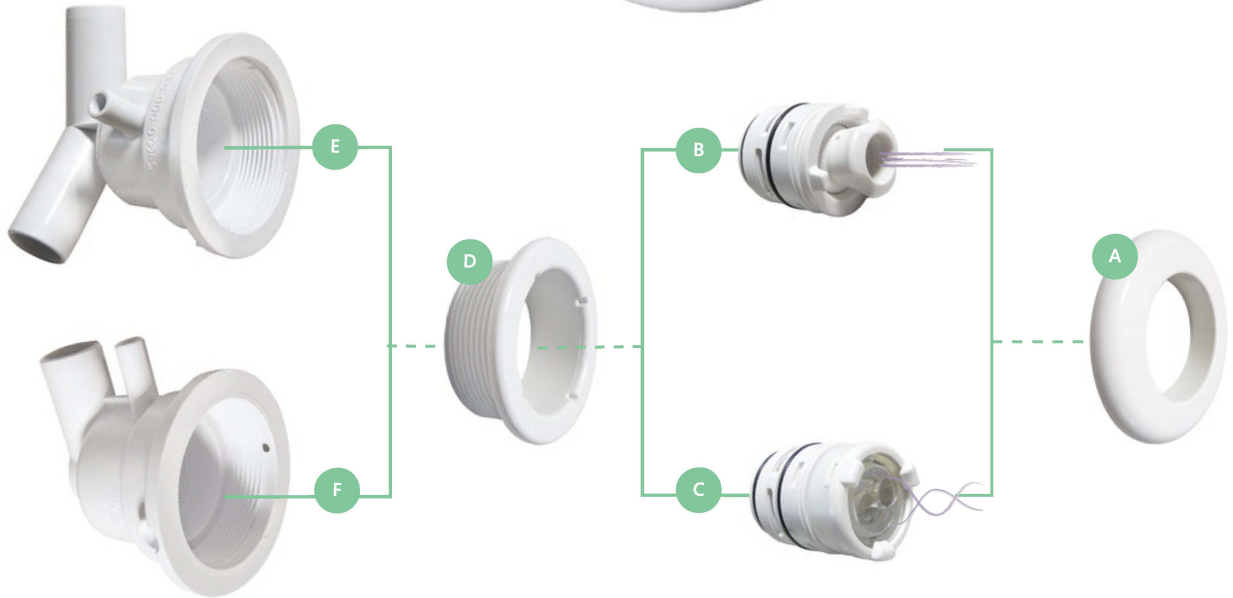

ORDERING GUIDE

REF	CMP P/N	DESCRIPTION	BAG/BOX
TECH SERIES TS-I JET			
A	24600-000-040	TS-I SMOOTH ESCUTCHEON	300
B	24600-000-000	TS-I DIRECTIONAL INTERNAL	400/100
C	24600-000-100	TS-I ROTATIONAL INTERNAL	400/100
D	24600-000-030	TS-I WALL FITTING	300
E	24600-000-010	TS-I "V" JET BODY	100
F	24600-000-020	TS-I "L" JET BODY	100
—	24600-999-999	TS-I TOOL FOR WALL FITTING	—
—	24600-399-999	TS-I TOOL FOR JET INTERNAL	—

TECH SERIES JETS

TS-II JET

PRODUCT FEATURES

- Smooth Flat Face
- Adjustable Flow
- Directional Nozzle
- Silicone Injection Ports



2-1/4" Hole Size
3/8" SB Air
26mm Water

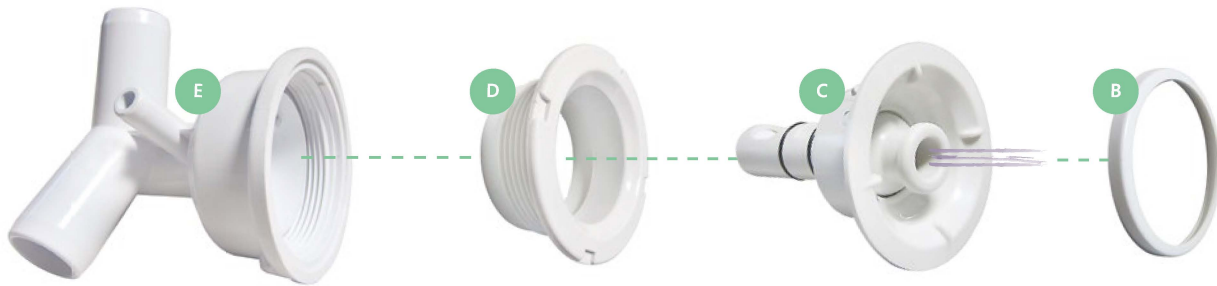

ORDERING GUIDE

REF	CMP P/N	DESCRIPTION	BOX QTY
TECH SERIES TS-II JET			
A	27270-900-000	TS-II COMPLETE DIRECTIONAL ASSEMBLY	80
B	27270-900-060	TS-II TRIM RING	100
C	27270-900-100	TS-II DIRECTIONAL JET INTERNAL	50
D	27270-900-050	TS-II WALL FITTING	100
E	27270-900-070	TS-II "V" JET BODY	100
—	27270-999-999	TS-II TOOL FOR WALL FITTING	—
—	27270-900-999	TS-II TOOL FOR JET INTERNAL	—

TECH SERIES JETS

TS-III JET

PRODUCT FEATURES

- Smooth Rounded Face
- Center Air Draw
- Adjustable Flow
- Directional Nozzle



ORDERING GUIDE

REF	CMP P/N	DESCRIPTION	BOX/BAG
TECH SERIES TS-III JET			
A	23061-000-000	TS-III COMPLETE DIRECTIONAL ASSEMBLY	60
A	23061-002-000	TS-III COMPLETE CHROME DIRECTIONAL ASSEMBLY	60
A	23061-000-133	TS-III COMPLETE BRASS DIRECTIONAL ASSEMBLY	60
B	23061-010-000	TS-III ESCUTCHEON/WALL FITTING	200/20
C	26200-230-601	TS-III GASKET	60
D	23061-000-100	TS-III NOZZLE & RING	60
D	23061-132-002	TS-III CHROME NOZZLE & RING	60
D	23061-132-003	TS-III BRASS NOZZLE & RING	60
E	23061-000-200	TS-III JET BODY ASSEMBLY	60
F	21022-000-000	1" PLUG (SOLD SEPARATELY)	500/25
—	27112-000-000	TS-III PLASTIC TOOL FOR JET	—
—	23061-999-999	TS-III METAL TOOL FOR JET	—
—	23061-090-000	RETAINING RING	—

TECH SERIES JETS

TS-IV JET

PRODUCT FEATURES

- Rounded Face Design
- Adjustable Flow
- Silicone Injection Ports
- Directional Nozzle



2-3/8" Hole Size
 3/8" SB Air
 1" S Water

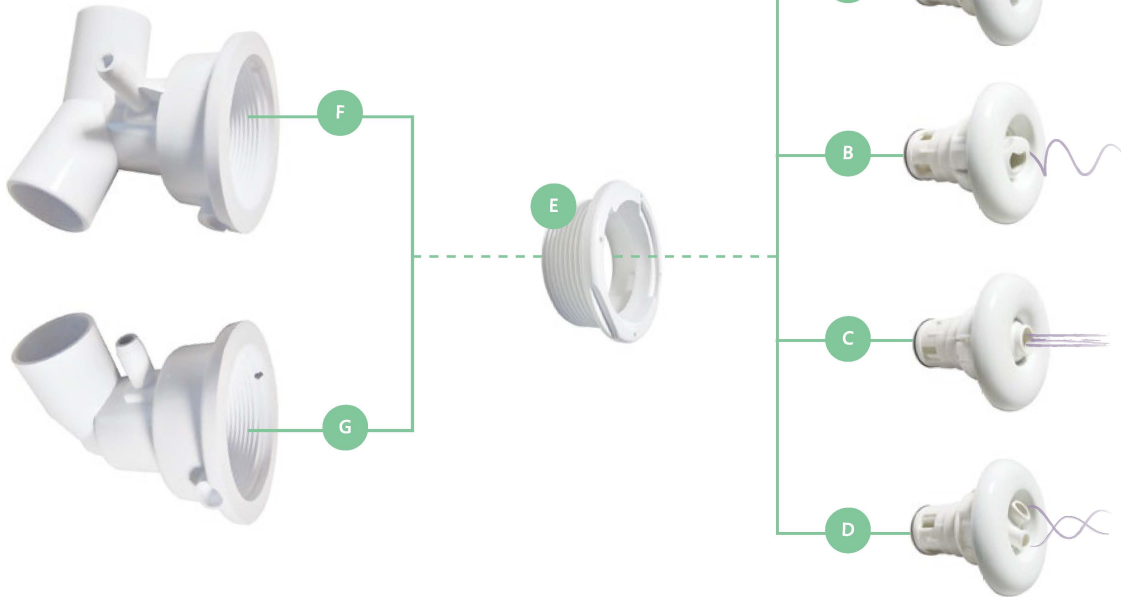

ORDERING GUIDE

REF	CMP P/N	DESCRIPTION	BOX QTY
TECH SERIES TS-IV JET			
A	27272-300-100	TS-IV SMOOTH ESCUTCHEON & DIRECTIONAL EYEBALL INTERNAL	240
B	27272-300-120	TS-IV SMOOTH ESCUTCHEON & SINGLE ROTO EYEBALL INTERNAL	240
C	27270-400-000	TS-IV ROUND ESCUTCHEON & DIRECTIONAL EYEBALL INTERNAL	240
D	27270-400-100	TS-IV ROUND ESCUTCHEON & DOUBLE ROTO EYEBALL INTERNAL	100
E	27270-300-040	TS-IV WALL FITTING	200
F	27272-300-200	TS-IV "V" JET BODY	100
G	27270-400-500	TS-IV "L" JET BODY	240
—	27270-399-999	TS-IV TOOL FOR WALL FITTING	—

TECH SERIES JETS

TS-V JET

PRODUCT FEATURES

- Scalloped Face Design
- Adjustable Flow
- Air Inlet
- Directional Nozzle



2-9/16" Hole Size
3/8" SB Air
26mm Water

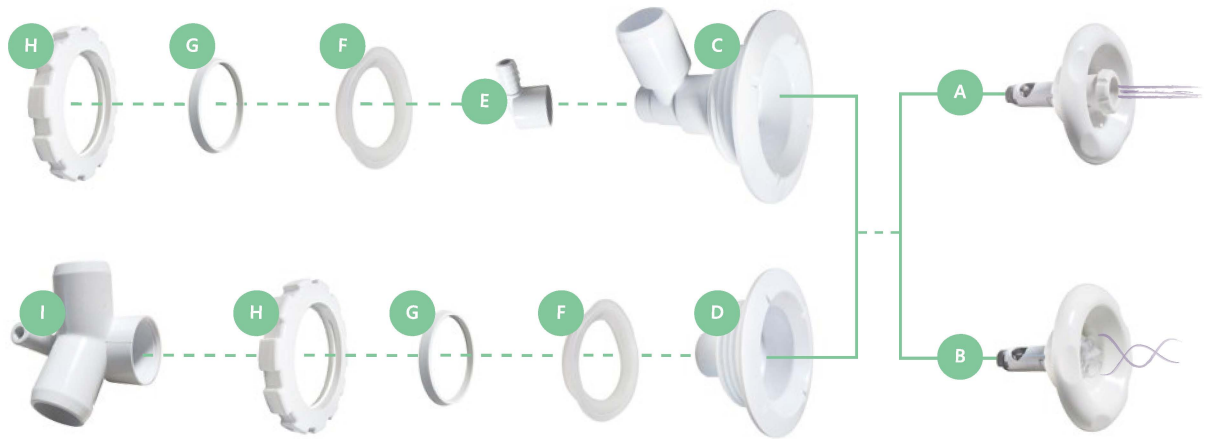

ORDERING GUIDE

REF	CMP P/N	DESCRIPTION	BOX/BAG
TECH SERIES TS-V JET			
A	24400-100-000	TS-V DIRECTIONAL INTERNAL & ESCUTCHEON	300
B	24401-100-000	TS-V DOUBLE ROTO INTERNAL & ESCUTCHEON	300
C	24400-000-000	TS-V "L" JET BODY	300
D	24400-000-004	TS-V WALL FITTING	500/50
E	24400-000-006	TS-V 3/8" AIR BARB FOR "L" JET BODY	2400
F	24400-000-008	TS-V "L" GASKET	1200
G	24400-000-007	TS-V COMPENSATOR RING	1800
H	24400-000-005	TS-V NUT	600
I	24400-000-001	TS-V "V" JET BODY	400
—	24400-999-999	TS-V TOOL FOR JET NUT	—

ECON SERIES JETS

100-E JET

PRODUCT FEATURES

- Five Face Design Options
- Adjustable or Non-Adjustable Flow
- Silicone Injection Ports
- CSA Certified



- 1-2/3" Hole Size
- 3/8" S. Barb Air × 1" Water
- 3/8" S. Barb Air × 26mm Water

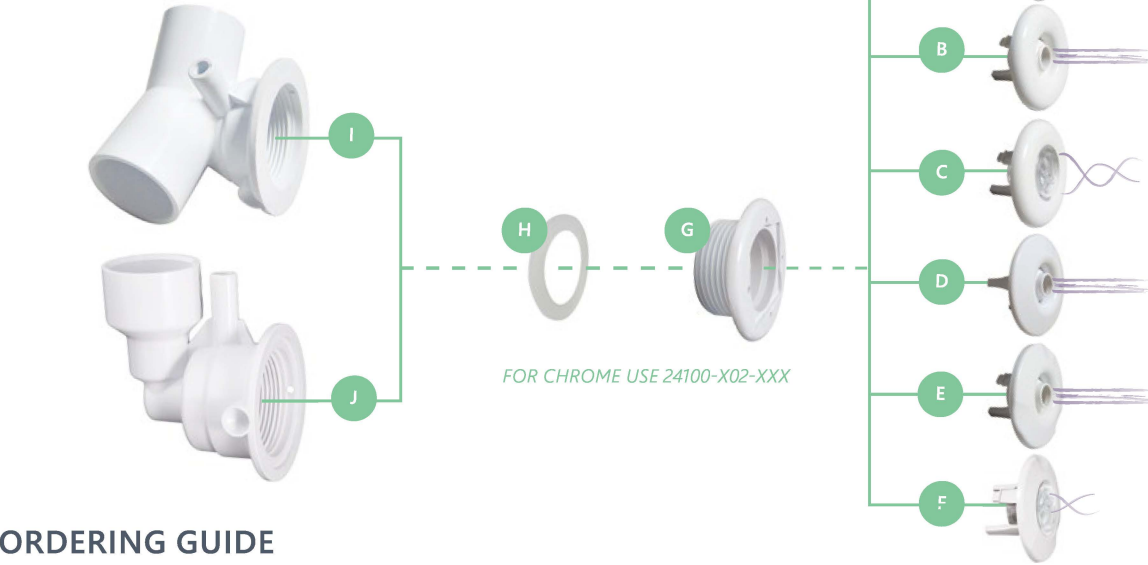

FOR CHROME USE 24100-X02-XXX

ORDERING GUIDE

REF	CMP P/N	DESCRIPTION	BOX/BAG
ECON SERIES 100-E JET			
A	24100-000-100	100-E SWIRL ESCUTCHEON DIRECTIONAL EYEBALL	1000/100
B	24100-000-300	100-E ROUND ESCUTCHEON DIRECTIONAL EYEBALL	1000/100
B	24100-000-500	100-E ROUND ESCUTCHEON DIR EYEBALL W/ EXTENDED LEGS FOR THICK TUBS	1000/100
C	24100-000-400	100-E ROUND ESCUTCHEON ROTO EYEBALL	100
C	24100-000-800	100-E ROUND ESCUTCHEON ROTO EYEBALL W/ EXTENDED LEGS FOR THICK TUBS	100
D	24100-100-100	100-E SMOOTH ESCUTCHEON DIRECTIONAL EYEBALL	100
E	24100-900-000	100-E 3-SCALLOP ESCUTCHEON DIRECTIONAL EYEBALL	800/100
F	24100-900-400	100-E 3-SCALLOP ESCUTCHEON AND ROTO EYEBALL	—
G	24100-000-040	100-E WALL FITTING	600/50
G	24100-000-052	100-E EXTENDED WALL FITTING FOR THICK TUB WALLS	600/50
H	24100-000-070	100-E GASKET	800
I	24100-000-200	1" V-BODY, ADJUSTABLE	100
I	24101-000-200	1" V-BODY, NON-ADJUSTABLE	100
I	24000-000-200	26MM V-BODY, ADJUSTABLE	250
I	24000-000-205	26MM V-BODY ADJUSTABLE WITH CHECK VALVE	—
I	24001-000-200	26MM V-BODY, NON-ADJUSTABLE	100
J	24100-000-220	1" L-BODY, ADJUSTABLE	100
J	24101-000-220	1" L-BODY, NON-ADJUSTABLE	100
J	24000-000-220	26MM L-BODY, ADJUSTABLE	100
J	24000-000-225	26MM L-BODY, ADJUSTABLE WITH CHECK VALVE	—
J	24001-000-220	26MM L-BODY, NON-ADJUSTABLE	100
—	24100-999-999	100-E TOOL FOR WALL FITTING	—

ECON SERIES JETS

200-E JET

PRODUCT FEATURES

- Smooth Face
- Adjustable Flow
- Directional Nozzle

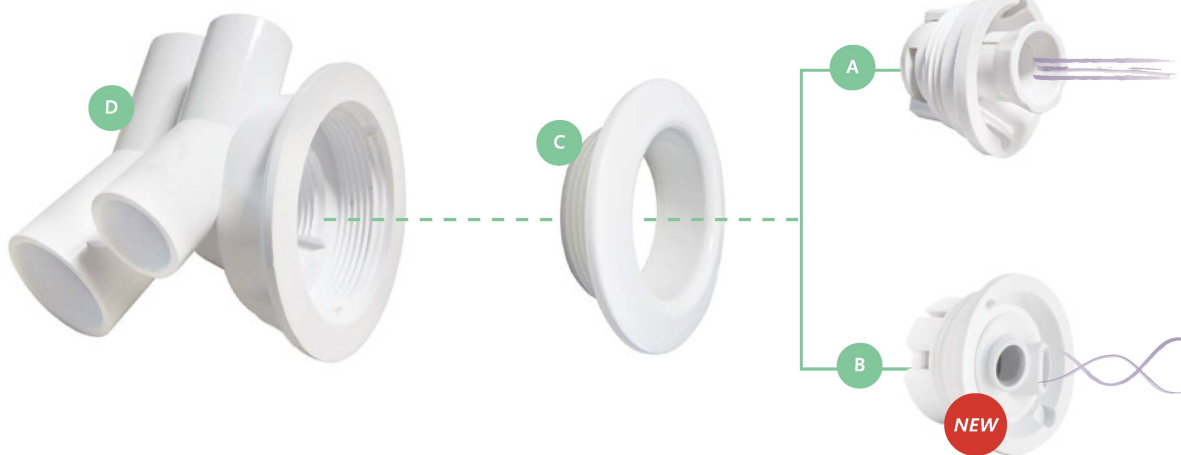
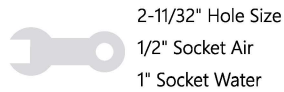

ORDERING GUIDE

REF	CMP P/N	DESCRIPTION	BOX QTY
ECON SERIES 200-E JET			
A	24300-200-000	200-E DIRECTIONAL NOZZLE ASSEMBLY	600
B	24302-000-000	200-E DOUBLE ROTO INTERNAL, WHITE	—
C	24300-300-000	200-E WALL FITTING	300
D	24300-100-000	200-E "V" JET BODY	100
D	24300-100-100	200-E "V" JET BODY WITH NO DRAIN CHANNEL	100
D	24300-100-200	200-E "V" JET SHORT BODY	—
D	24300-100-300	200-E "V" JET SHORT BODY WITH NO DRAIN CHANNEL	—
—	24300-000-070	200-E GASKET FOR DRAIN CHANNEL	200
—	24300-299-999	200-E NOZZLE ASSEMBLY WRENCH	—
—	24300-799-999	200-E COMBO WALL FITTING AND INTERNAL TOOL	—

ECON SERIES JETS

300-E JET

PRODUCT FEATURES

- Rounded Face Design
- Non-Adjustable Flow
- Directional Nozzle



1-11/16" Hole Size
 1/2" Socket Air
 1" Socket Water

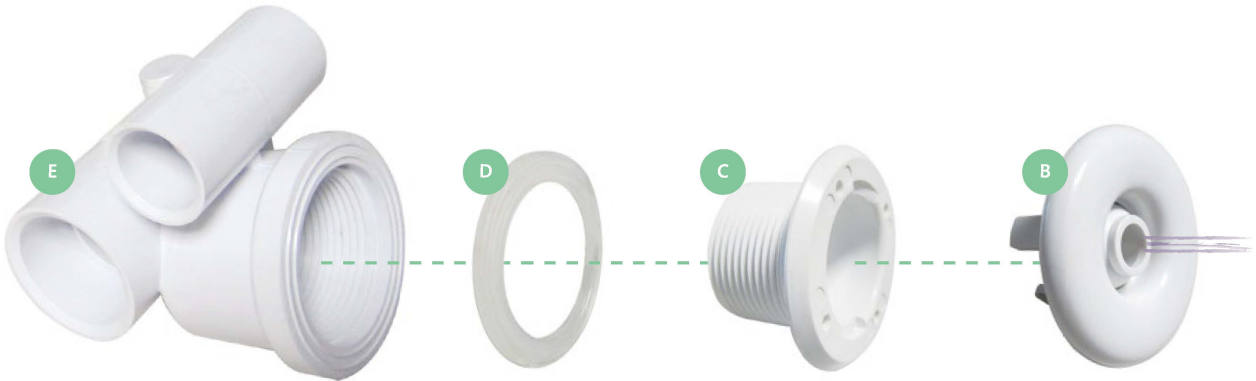

ORDERING GUIDE



REF	CMP P/N	DESCRIPTION	BOX QTY
ECON SERIES 300-E JET			
A	23071-000-000	300-E DIRECTIONAL ASSEMBLY	100
B	23071-000-100	300-E ESCUTCHEON & EYEBALL INSERT	100
C	23071-030-000	300-E WALL FITTING	100
D	26205-804-330	300-E GASKET	100
E	23071-000-200	300-E STRAIGHT JET BODY	100
—	23072-000-000	300-E TOOL FOR WALL FITTING	—

ECON SERIES JETS

300-EA JET

PRODUCT FEATURES

- Rounded or 3-Scallop Eyeball
- Directional Nozzle
- Adjustable Flow

-  1-11/16" Hole Size
-  1/2" Socket Air
-  1" Socket Water



ORDERING GUIDE

REF	CMP P/N	DESCRIPTION	BOX QTY
ECON SERIES 300-EA JET			
A	23070-000-000	300-EA DIRECTIONAL ASSEMBLY	120
A	23070-200-000	300-EA "V" JET DIRECTIONAL ASSEMBLY	120
B	23070-000-100	300-EA ESCUTCHEON & EYEBALL INSERT	100
C	23070-030-000	300-EA WALL FITTING	100
D	24100-900-000	100-E 3-SCALLOP ESCUTCHEON DIRECTIONAL EYEBALL	800/100
E	23070-130-000	300-EA WALL FITTING FOR 3-SCALLOP ESCUTCHEON DIRECTIONAL EYEBALL	600/50
F	26205-804-330	300-EA GASKET	100
G	23070-000-200	300-EA STRAIGHT JET BODY	100
—	23070-000-220	300-EA JET INTERNAL ONLY WITH STAR ORIFICE	—
H	23070-200-200	300-EA "V" JET BODY	100
—	23072-000-000	300-EA TOOL FOR WALL FITTING	800/100
—	24100-999-999	100-E 3-SCALLOP ESCUTCHEON WALL FITTING TOOL	—

ECON SERIES JETS

400-E JET

PRODUCT FEATURES

- Rounded Face Design
- Non-Adjustable



1-11/16" Hole Size

1" Socket Air

1" Socket Water

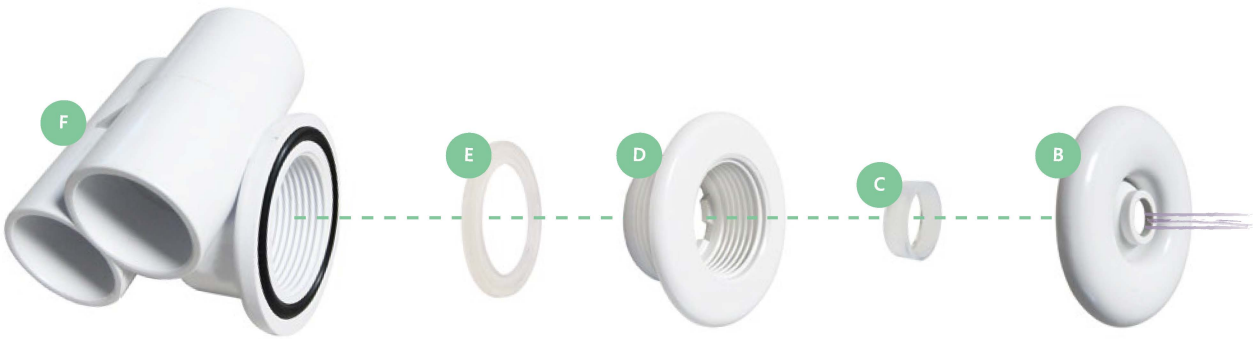

ORDERING GUIDE

REF	CMP P/N	DESCRIPTION	BOX QTY
ECON SERIES 400-E JET			
A	23062-000-000	400-E COMPLETE DIRECTIONAL ASSEMBLY	100
B	23062-000-100	400-E ESCUTCHEON & EYEBALL	100
C	23062-050-000	400-E EYEBALL RETAINER RING	50
D	23062-020-000	400-E WALL FITTING	100
E	26205-554-230	400-E GASKET	100
F	23062-000-200	400-E JET BODY & O-RING	100
—	23062-999-999	400-E TOOL FOR WALL FITTING	—

ECON SERIES JETS

500-E JET

PRODUCT FEATURES

- Traditional 5-Scallop Design
- Adjustable Flow
- Silicone Injection Ports



2-1/8" Hole Size

1/2" Socket Air

1" Socket Water

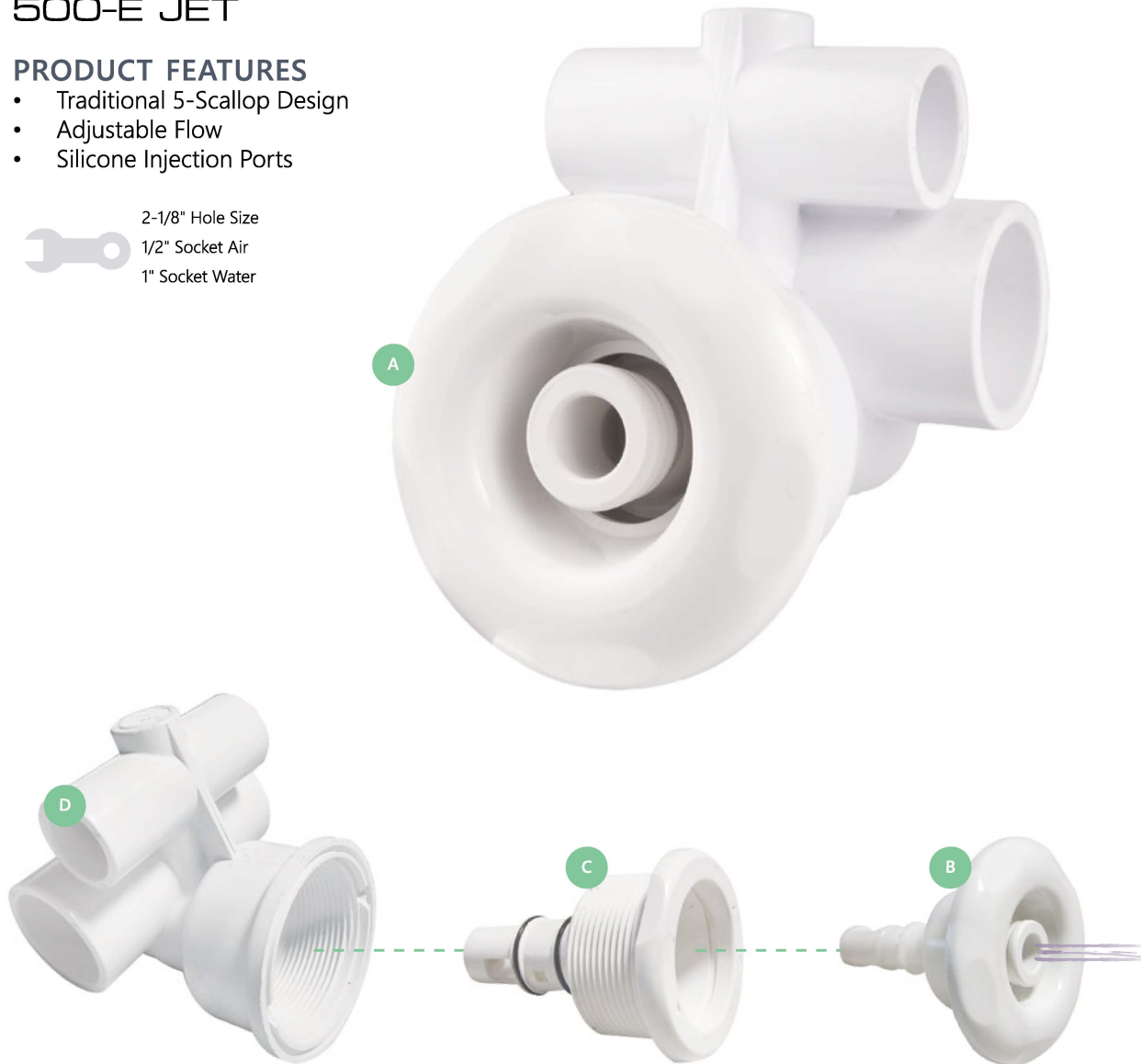

ORDERING GUIDE

REF	CMP P/N	DESCRIPTION	BOX QTY
ECON SERIES 500-E JET			
A	27270-000-000	500-E COMPLETE DIRECTIONAL ASSEMBLY	100
B	27270-100-200	500-E 5-SCALLOP ESCUTCHEON & EYEBALL INSERT	100
C	27270-100-050	500-E WALL FITTING	100
D	27270-200-000	500-E JET BODY	100

BATH SERIES JETS

3" BATH SERIES

PRODUCT FEATURES

- Rounded Face
- Adjustable Flow
- Directional Nozzle

-  2-3/16" Hole Size
-  3/8" SB Air
-  3/4" S Water
-  1" SP / 26mm SP Water

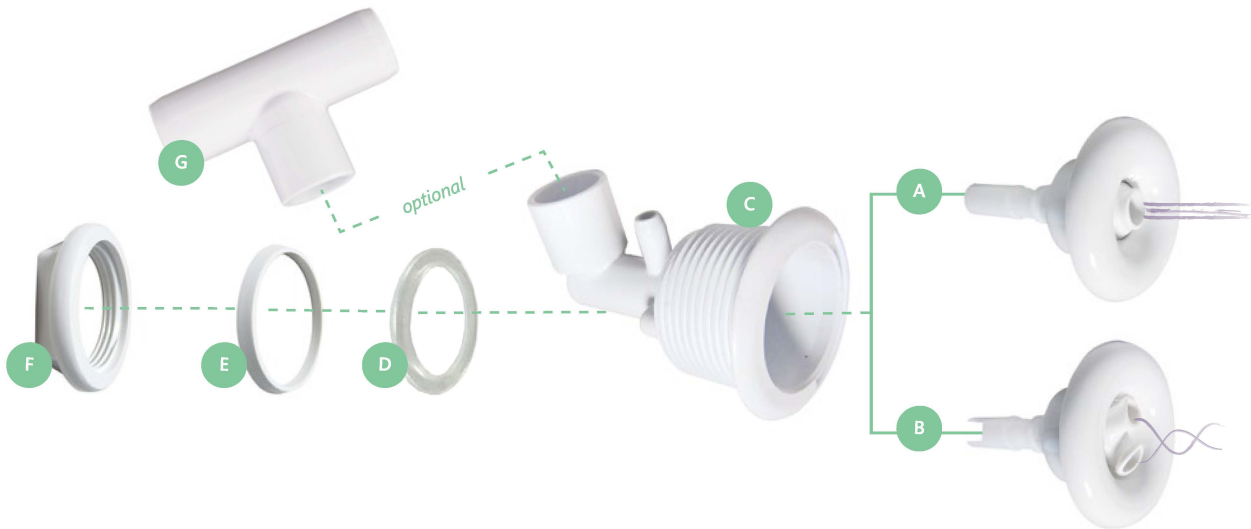

ORDERING GUIDE

REF	CMP P/N	DESCRIPTION	BOX QTY
3" BATH SERIES JET			
A	23432-500-000	3" ROUND ESCUTCHEON AND DIRECTIONAL INTERNAL	50
B	23432-500-100	3" ROUND ESCUTCHEON AND ROTATIONAL INTERNAL	50
C	23432-500-500	3" "L" JET BODY	100
D	23432-000-050	3" "L" GASKET	100
E	23432-000-010	3" COMPENSATOR RING	100
F	23432-000-040	3" NUT FOR JET BODY	100
G	24202-126-000	3/4" SLIP TO 26MM TEE ADAPTER	100
—	23432-999-999	3" TOOL FOR JET NUT	—

BATH SERIES JETS

3" BATH SERIES (100% SHUT-OFF)

PRODUCT FEATURES

- Rounded Face
- 100% Shut-Off Capable
- Adjustable Flow
- Directional Nozzle



2-3/16" Hole Size
3/4" S Water
1" SP / 26mm SP Water

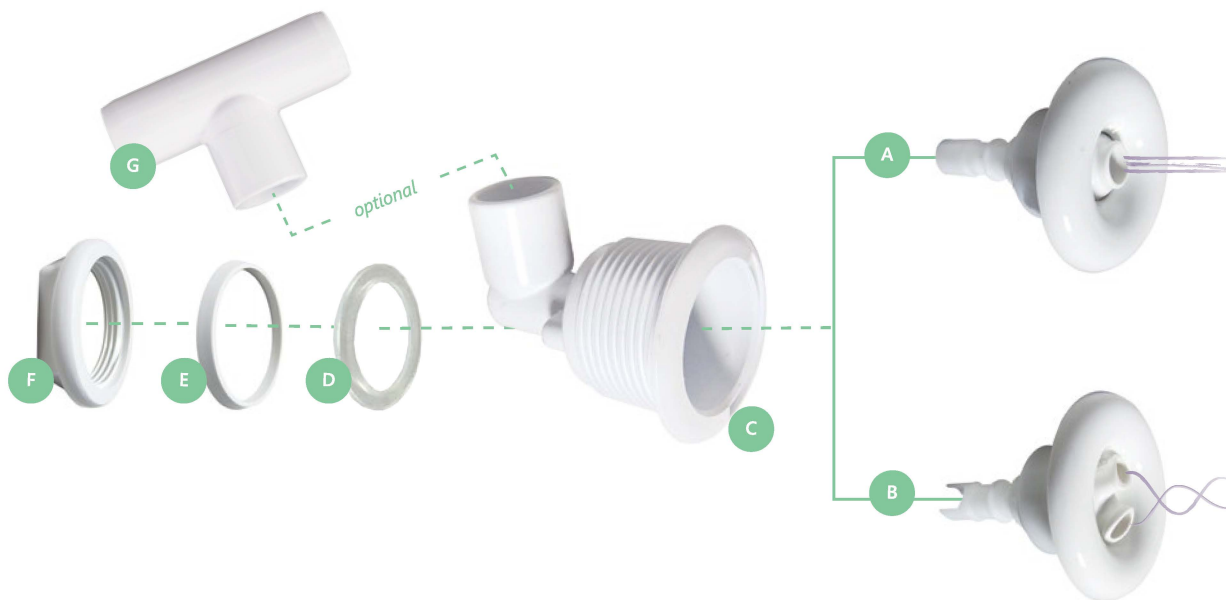

ORDERING GUIDE

REF	CMP P/N	DESCRIPTION	BOX QTY
3" BATH SERIES JET (100% SHUT-OFF)			
A	23432-700-000	3" SHUT-OFF ROUND ESCUTCHEON AND DIRECTIONAL INTERNAL	50
B	23432-700-100	3" SHUT-OFF ROUND ESCUTCHEON AND ROTATIONAL INTERNAL	50
C	23432-700-500	3" SHUT-OFF "L" JET BODY	100
D	23432-000-050	3" "L" GASKET	100
E	23432-000-010	3" COMPENSATOR RING	500
F	23432-000-040	3" NUT FOR JET BODY	100
G	24202-126-000	3/4" SLIP TO 26MM TEE ADAPTER	100
—	23432-999-999	3" TOOL FOR JET NUT	—

BATH SERIES JETS

2" BATH SERIES

PRODUCT FEATURES

- Rounded Face
- Adjustable Flow
- Uni-Directional Nozzle

- 1-1/2" Hole Size
- 3/8" SB Air
- 3/4" S Water
- 1" SP / 26mm SP Water

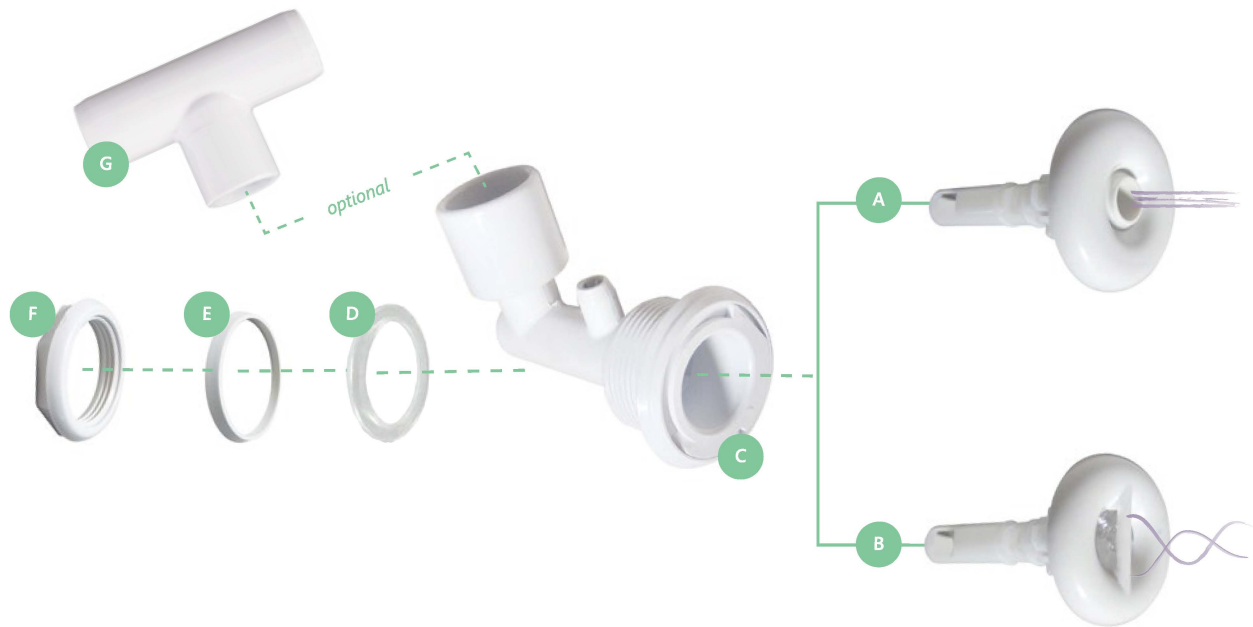

ORDERING GUIDE

REF	CMP P/N	DESCRIPTION	BOX/BAG
2" BATH SERIES JET			
A	23422-500-000	2" ROUND ESCUTCHEON AND DIRECTIONAL INTERNAL	50
B	23422-500-100	2" ROUND ESCUTCHEON AND ROTATIONAL INTERNAL	50
C	23422-500-500	2" "L" JET BODY	100
D	23422-000-050	2" "L" GASKET	100
E	23422-000-010	2" COMPENSATOR RING	100
F	23422-000-040	2" NUT FOR JET BODY	100
G	24202-126-000	3/4" SLIP TO 26MM TEE ADAPTER	100
—	23422-999-999	2" TOOL FOR JET NUT	—

MINI JETS

MICRO JET

PRODUCT FEATURES

- Adjustable Flow
- Silicone Injection Ports
- Directional or Roto Nozzle

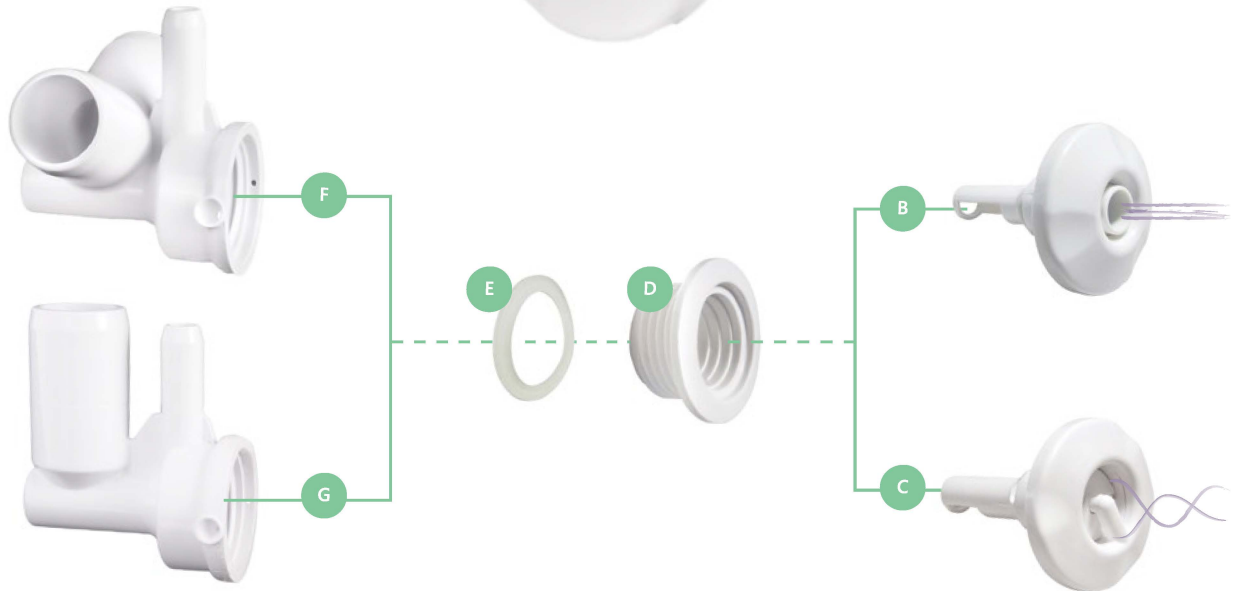

ORDERING GUIDE

REF	CMP P/N	DESCRIPTION	BOX/BAG
MICRO JET			
A	23401-900-000	MICRO JET ROTATIONAL ASSEMBLY (PICTURED)	120
A	23400-900-000	MICRO JET DIRECTIONAL ASSEMBLY	120
B	23400-900-100	MICRO JET 3-SCALLOP & DIRECTIONAL EYEBALL INSERT	50
C	23401-900-100	MICRO JET 3-SCALLOP & ROTATIONAL EYEBALL INSERT	50
D	23400-940-040	MICRO JET WALL FITTING	100
E	23400-900-050	MICRO JET GASKET	100
F	23400-900-030	26MM MICRO JET V-BODY, ADJUSTABLE WITH CHECK VALVE	100
G	23400-900-060	26MM MICRO JET L-BODY, ADJUSTABLE WITH CHECK VALVE	100
G	23400-950-060	26MM MICRO JET L-BODY, ADJUSTABLE	100
—	23400-999-999	MICRO V TOOL FOR WALL FITTING	—

MINI JETS

EURO JETS



PRODUCT FEATURES

- Low Profile Design Allows for Multiple Plumbing Variations
- Non-Adjustable
- Directional, Rotational and Uni-Directional Nozzles

 15/16" Hole Size
CSA Approval

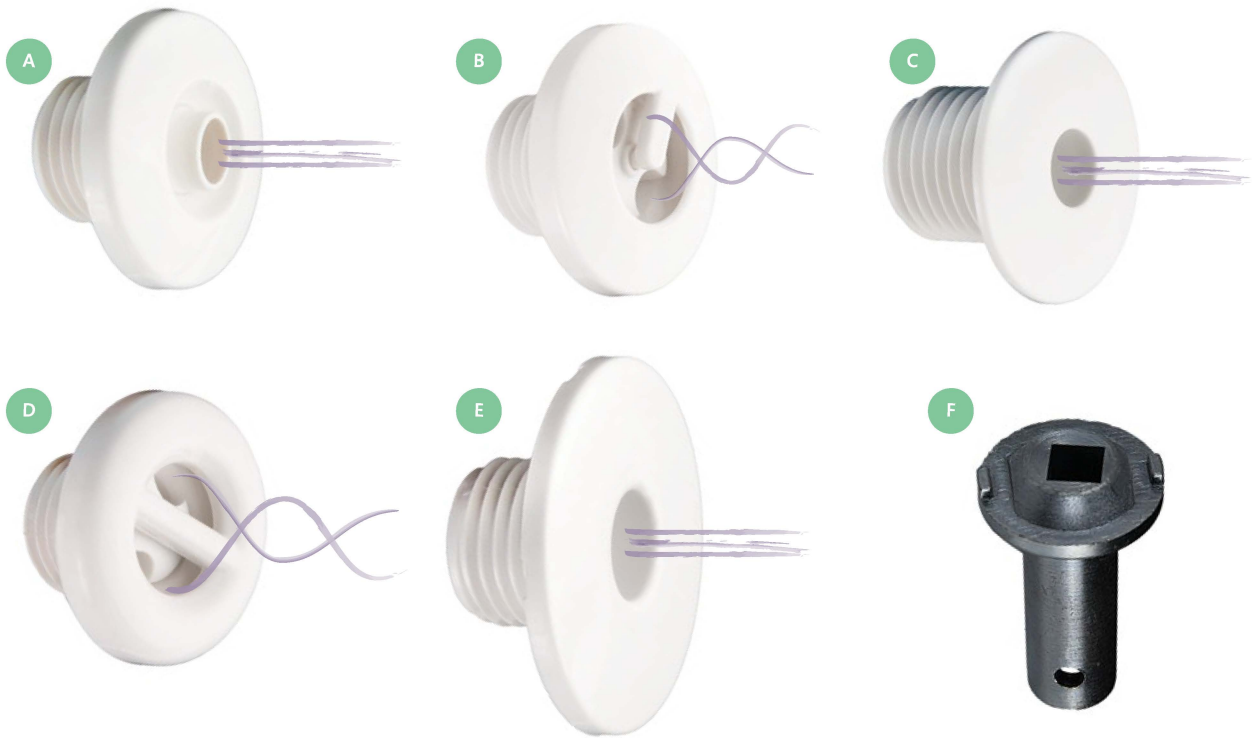

ORDERING GUIDE

REF	CMP P/N	DESCRIPTION	BOX/BAG
EURO JETS			
A	24500-900-000	1-5/8" DIRECTIONAL SMOOTH FACE EURO JET	1000/50
B	24510-900-000	1-5/8" ROTATIONAL SMOOTH FACE EURO JET	1000/50
C	24522-000-000	1-1/2" UNI-DIRECTIONAL SMOOTH FACE EURO JET	1000/50
D	23500-300-000	1-5/8" ROTATIONAL ROUNDED FACE EURO JET	1000/50
E	24530-000-000	2" UNI-DIRECTIONAL SMOOTH FACE EURO JET	1000/50
F	24500-999-999	EURO JET WALL FITTING TOOL	—

MINI JETS

EURO JET BODIES

PRODUCT FEATURES

- 3/8" and 1/2" Water Connections
- Fits all Euro Jet Internal Styles
- CSA Certified Options



ORDERING GUIDE

REF	CMP P/N	DESCRIPTION	BOX/BAG
EURO JET BODIES			
A	23400-400-060	1/2" SPIGOT WATER × 3/8" RIBBED BARB AIR	1000/50
A	23400-400-030	1/2" SPIGOT WATER × 3/8" RIBBED BARB AIR WITH SILICONE PORTS	1000/50
B	23400-500-000	3/8" RIBBED BARB WATER	1000/50
C	23400-600-000	1/2" SPIGOT WATER, NO AIR	1000/50
FITTINGS & ACCESSORIES			
D	21042-600-000	26MM BARB TEE FITTING	1000/50
E	21034-600-000	26MM BARB ELL FITTING	1000/50
F	21042-900-000	26MM "V" ADAPTER	400/50
G	26203-202-215	EURO JET CLEAR GASKET	1000/50

BATH DESIGN INFOGRAPHIC

HOSE & TUBING REFERENCE

(see page 77)

- 1.5" Tubing
- 3/8" Air Line
- Flex Tubing
- Air Button Tubing

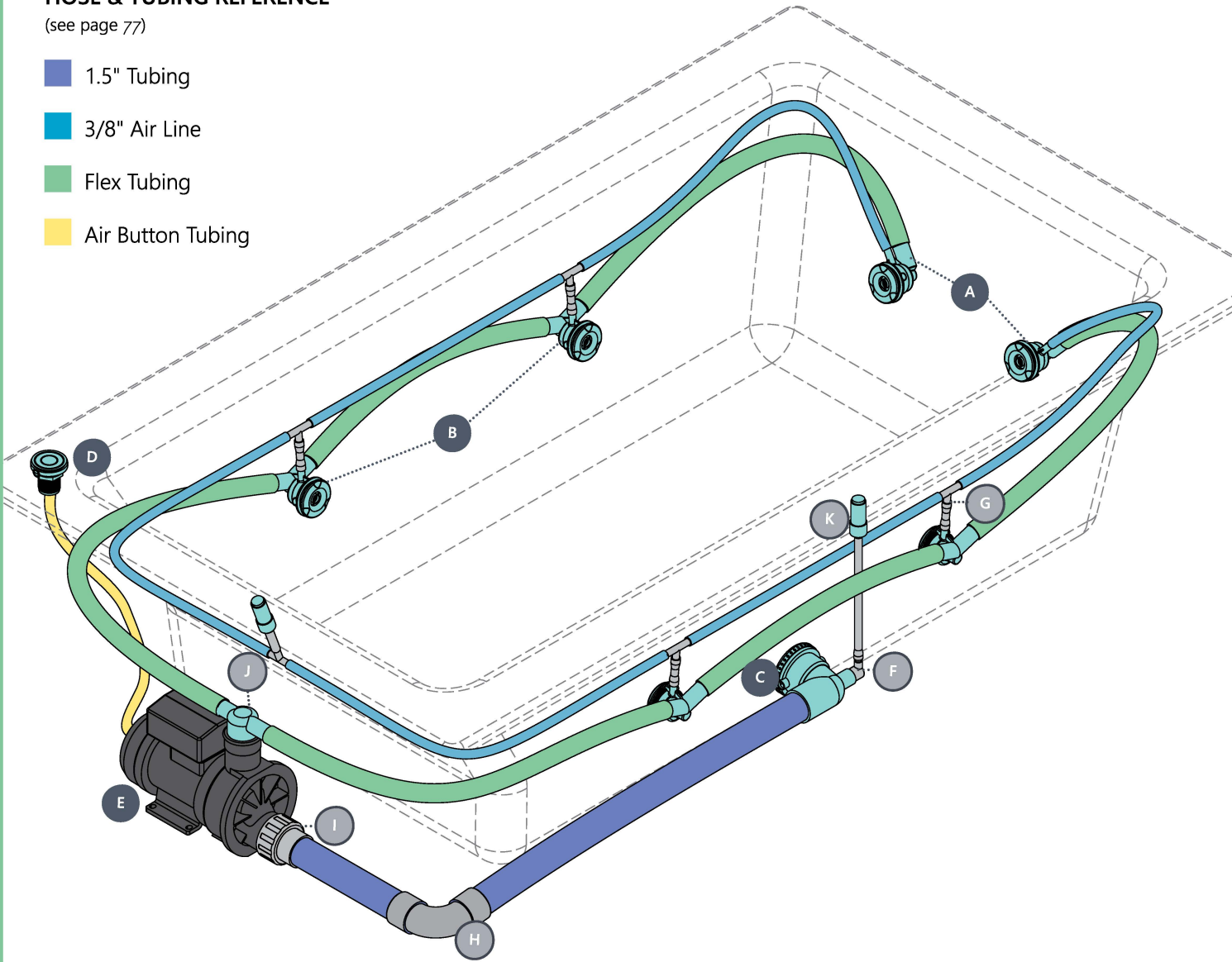

DIAGRAM GUIDE

REF	DESCRIPTION	PAGE
BATH COMPONENTS		
A	100-E "L" JET BODY	22
B	100-E "V" JET BODY	22
C	110 GPM LOW PROFILE SUCTION	72
D	SLIM AIR BUTTON	63
E	NEXXUS II PUMP, TOP DISCHARGE	54

REF	DESCRIPTION	PAGE
WHITE GOODS		
F	ELL BARB	76
G	3/8" TEE	76
H	1.5" SWEEP 90	74
I	PUMP UNION	75
J	PUMP TEE UNION	75
K	CHECK VALVE	75

Caresse

A REVOLUTIONARY BATHING EXPERIENCE

The Caresse® silent therapy system creates a complete escape with natural, gentle relaxing motion.

The innovative patent-pending design creates a soothing style of water therapy using the unique vented jet design. Unlike turbulent air and water jets, Caresse gently wraps your body in ribbons of warm water.

Gentle flow combined with relaxing heat and LED chromatherapy; Caresse® enhances your body, mind and spirit.



Caresse® gently wraps your body in ribbons of warm water.

GENTLE THERAPY

Caresse® end and side vents create a swirling, layered current throughout the bath. The warm, gentle and natural flow of water relaxes muscles, increases blood flow, and relieves stress.

CARESSE® END JET VENTS

End Vents create ribbons of water that flow over the top and front of your body.

CARESSE® SIDE JET VENTS

Side Vents envelop your body and can be adjusted to create unique flow patterns.



A. ADJUSTABILITY

Caresse® side vents can be rotated to any position you desire. Direct ribbons of water along your body and drift away, or adjust the flow direction to create a soothing swirl of water.

B. WATER MOVEMENT ONLY

Without air to agitate, the smooth ribbon-like flow of water is gentle and silent.

Caresse®

WHERE WILL YOUR BATHING RITUAL TAKE YOU?™

CARESSE® SYSTEM

CARESSE® JETS

PRODUCT FEATURES

- Silicone Injection Ports
- Gentle Water Flow
- Non-Adjustable Flow

 1-11/16"/42.4mm Hole Size
3/8" Air
26mm" Water

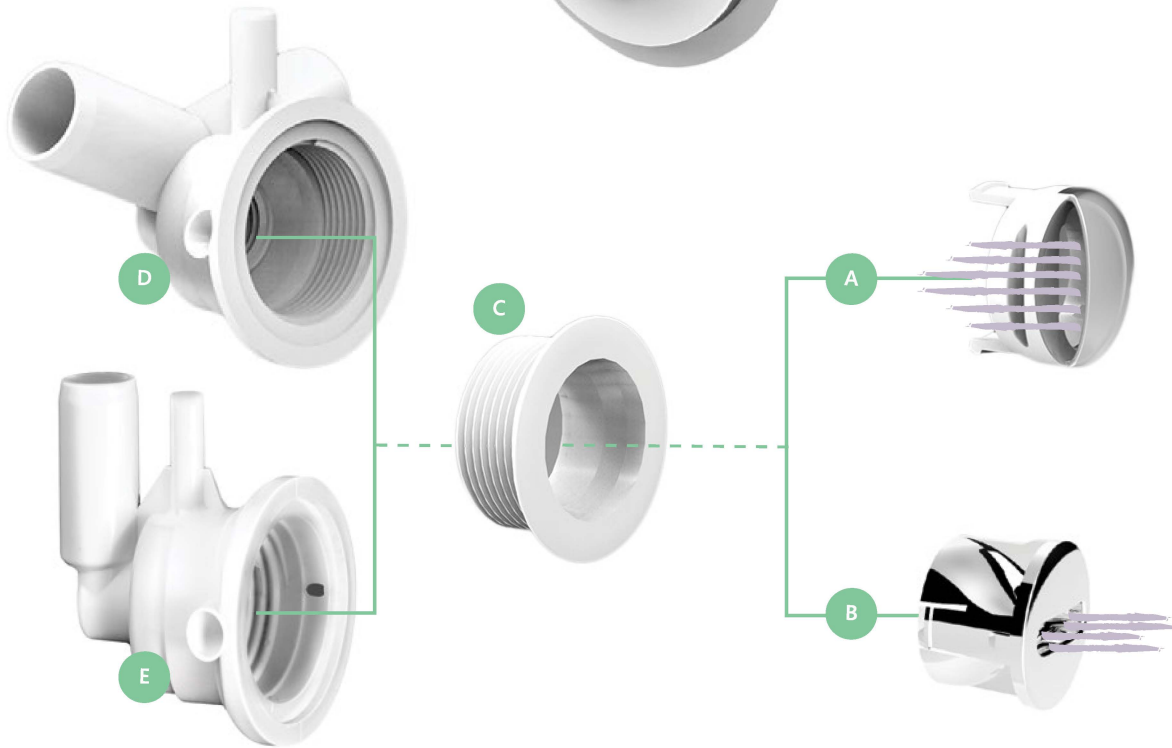

ORDERING GUIDE

REF	CMP P/N	DESCRIPTION	BOX/BAG
CARESSE® JETS			
A	24100-000-081	CARESSE® SIDE JET INTERNAL	100
B	24100-000-094	CARESSE® SLOTTED JET INTERNAL	100
C	24100-000-090	CARESSE® WALL FITTING	100
D	24001-000-211	26MM V-BODY WITH 3/8" PLUG, NON-ADJUSTABLE	100
D	24100-000-211	1" V-BODY WITH 3/8" PLUG, NON-ADJUSTABLE	100
E	24001-000-221	26MM L-BODY WITH 3/8" PLUG, NON-ADJUSTABLE	100
E	24101-000-221	1" L-BODY WITH 3/8" PLUG, NON-ADJUSTABLE	100
—	27240-148-000	NEXXUS Q PUMP, 120V (US)	—
—	27240-248-000	NEXXUS Q PUMP, 220V (EUROPE)	—
—	24100-000-999	WALL FITTING TOOL	—

CARESSE® SYSTEM DESIGN INFOGRAPHIC

HOSE & TUBING REFERENCE

(see page 77)

- 1.5" Tubing
- Flex Tubing
- Air Button Tubing

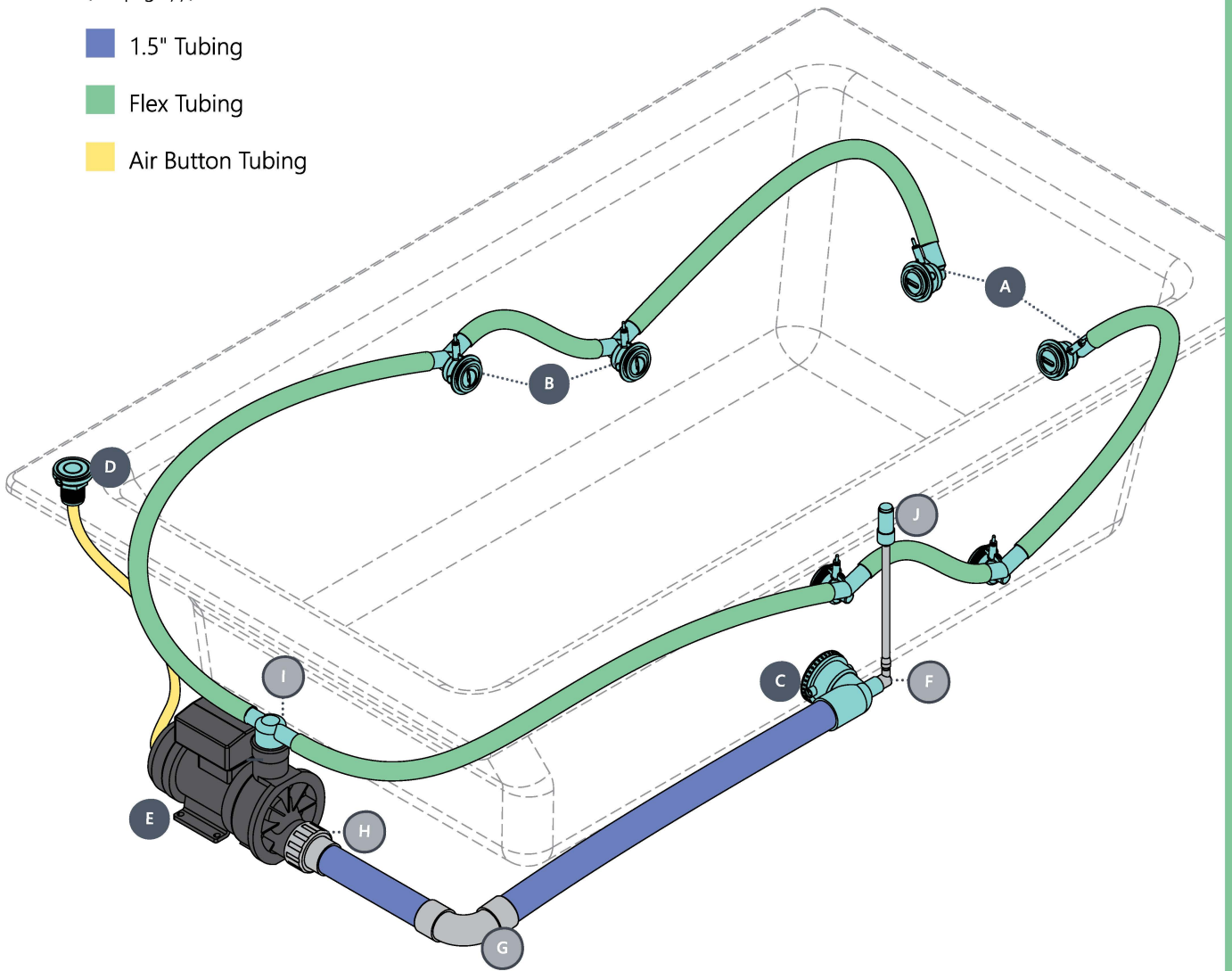

DIAGRAM GUIDE

REF	DESCRIPTION	PAGE	REF	DESCRIPTION	PAGE
CARESSE SYSTEM COMPONENTS			WHITE GOODS		
A	CARESSE SLOTTED "L" JET	38	F	ELL BARB	76
B	CARESSE SIDE JET WITH "V" BODY	38	G	1.5" SWEEP 90	74
C	110 GPM LOW PROFILE SUCTION	72	H	PUMP UNION	75
D	SLIM AIR BUTTON	63	I	PUMP TEE UNION	75
E	NEXXUS Q PUMP	38	J	CHECK VALVE	75

BATH CONTROLS & EQUIPMENT

NEXXUS™ CONTROLS *42*

NEXXUS™ PUMPS *54*

NEXXUS™ DH HEATERS *58*

NEXXUS™ AIR BLOWERS *59*

Nexxus™

BATH CONTROLS

NEW

- Complete Suite of Expandable Bath Controls
- Custom Programming Options
- Capacitive Touch Buttons: No Moving Parts
- Solenoid Control Capabilities
- Chrome or White Bezels



Nexus™ Bath Controls from CMP offer a full suite of options for whirlpool bath control. This complete collection includes programmable LCD style controls and "basic" options in one to six button sizes.

NEXXUS™ LCD SERIES

- Interactive LCD Feedback Screen
- Programmable Functions
- Four and Two Button Options
- Solenoid Capabilities

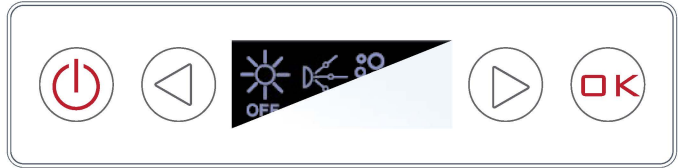

NEXXUS™ TOUCH SERIES

- Six and Four Button Configurations
- Capacitive Touch Buttons
- Pump, Blower, Light & Lock Operations
- Seven Available Functions

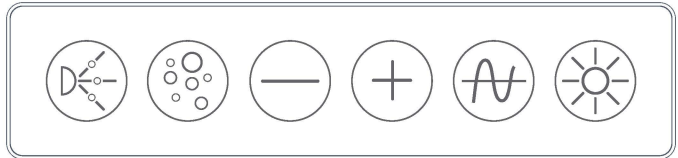

NEXXUS™ TOUCH SERIES; ROUND

- Single and Three Button Options
- Simple, Compact Round Controls
- Capacitive Touch Buttons
- Economical Choices
- Three Available Functions

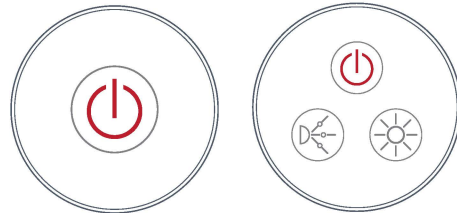

COMPLETE NEXXUS™ CONTROL SYSTEM

PRODUCT FEATURES

- Flexible, Expandable System Design
- Labeled Cord Connections for Easy Installation and Troubleshooting
- Multiple B4 Solenoid Controllers Can Be Used with Slave Connection

DIGITAL CONTROL SYSTEM (B1,B2,B6)

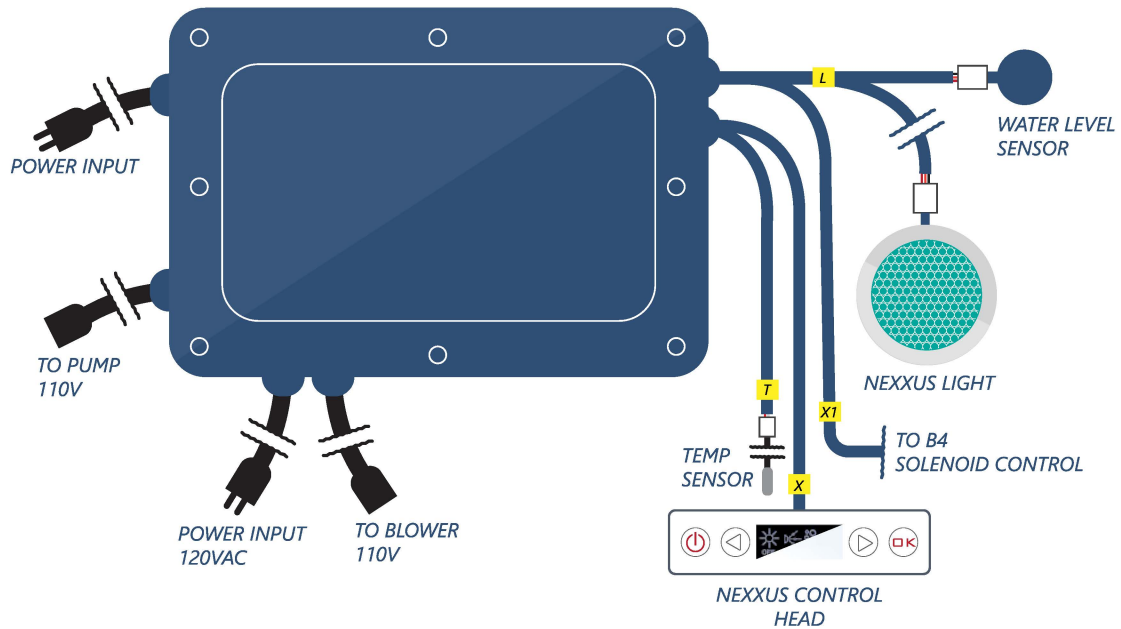

SOLENOID CONTROL SYSTEM (B4)

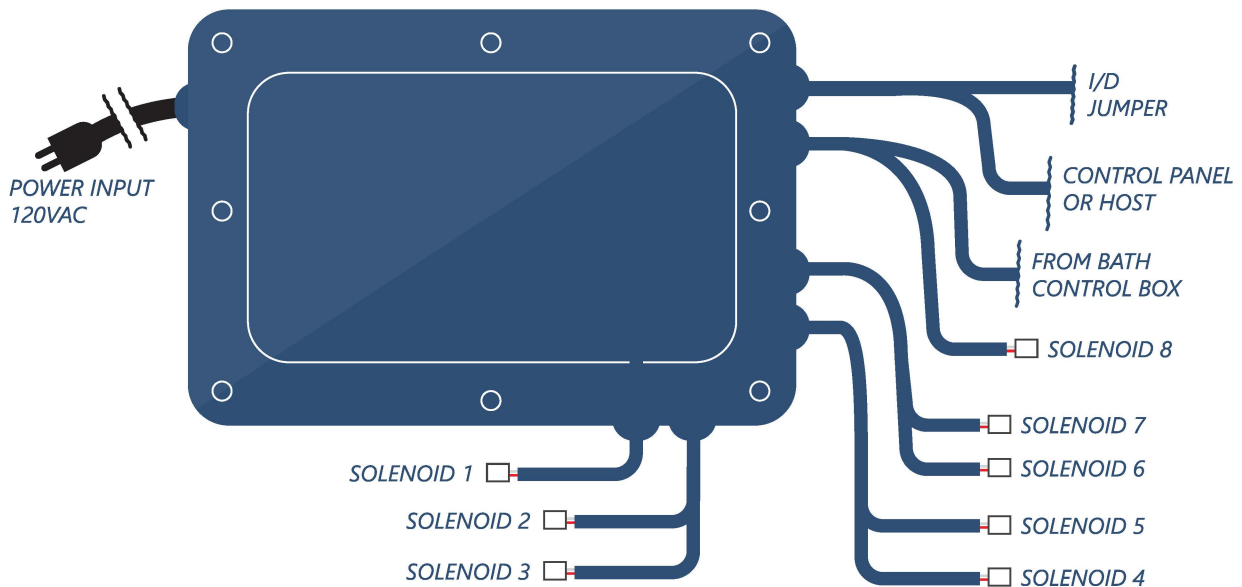

*All options shown. Available features vary between control box model.

NEXXUS™ BATH CONTROLLER BOXES

DIGITAL CONTROLLERS

PRODUCT FEATURES

- Three Configuration Options
- Control Pump, Blower, Lights
- Control Head Sold Separately
- Links with Solenoid Controller

SPECIFICATIONS

DIMENSIONS	5-1/2" × 7-3/8" × 2-1/2"
FUNCTIONS	SINGLE SPEED PUMP OPERATION VARIABLE SPEED BLOWER OPERATION LIGHT OPERATION AUTOMATIC TIMER PURGE CYCLE B4 CONTROLLER OPERATION
TEMP SENSOR	OPTIONAL
WATER SENSOR	2-WIRE OR 3-WIRE

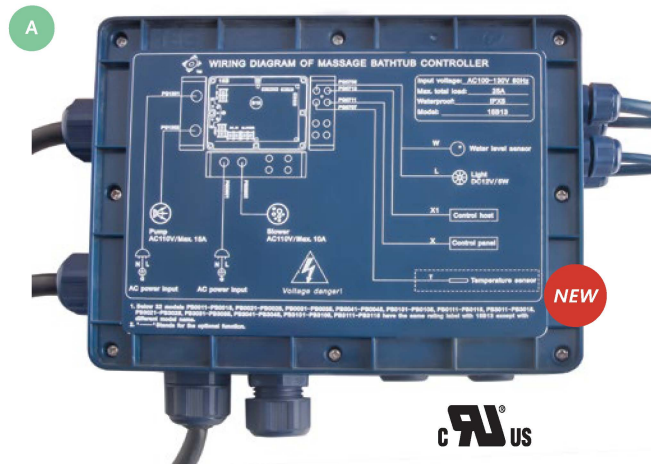

SOLENOID VALVE CONTROLLER

PRODUCT FEATURES

- Create Massage Therapy Experiences
- Alternating Jet Patterns & Speeds
- Solenoids Sold Separately
- Eight Solenoid Outputs
- Bath Controller Required

SPECIFICATIONS

DIMENSIONS	6-7/8" × 9-3/8" × 2-1/2"
ELECTRICAL	
INPUT VOLTAGE	120VAC @ 60HZ
MAX LOAD	1A MAX
SOLENOID OUTPUT	24VAC/10W

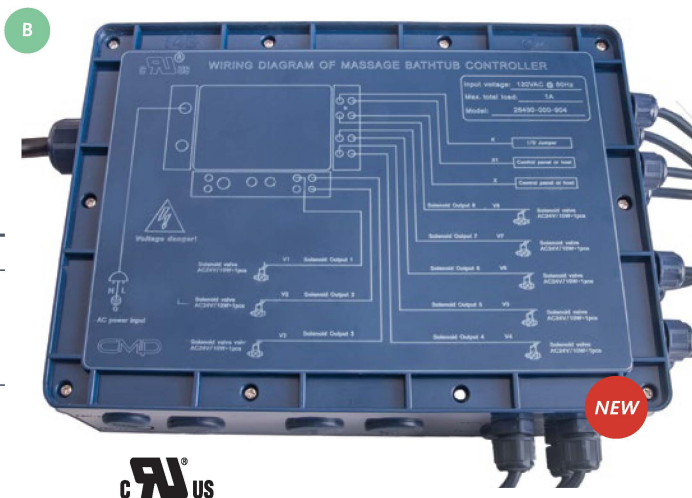

ORDERING GUIDE

REF	CMP P/N	DESCRIPTION	PUMP	BLOWER	LIGHT	SOLENOID VALVE
NEXXUS BATH CONTROL BOXES						
A	26400-000-901	B1 BATH CONTROLLER	✓	—	✓	—
A	26400-000-902	B2 BATH CONTROLLER	✓	✓	✓	—
A	26400-000-906	B6 BATH CONTROLLER	—	✓	✓	—
B	26400-000-904	B4 SOLENOID VALVE CONTROLLER	—	—	—	✓

NEXXUS™ LCD: FOUR BUTTON

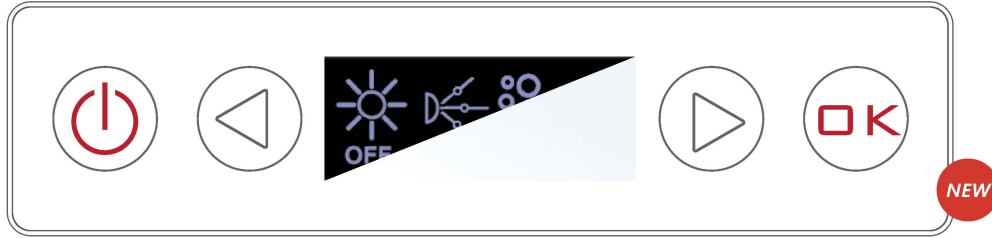

PRODUCT FEATURES

- Capacitive Touch Keys
- Back-lit Screen & Key
- White or Chrome Bezel Trim
- LCD Screen Operation
- 27 Pre-Programmed Configurations
- Multiple Seat Control
- Solenoid Valve Compatible
- Wave and Pulse Blower Operation

SPECIFICATIONS

FUNCTIONS	
PUMP OPERATION	
BLOWER OPERATION	
LIGHT OPERATION	
SOLENOID OPERATION	
AUTOMATIC TIMER	
PURGE CYCLE	
TEMP SENSOR	
OPTIONAL	
WATER SENSOR	
2-WIRE OR 3-WIRE	

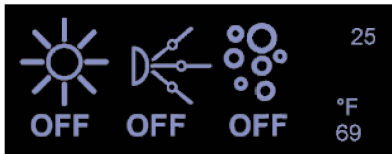

MAIN SCREEN

Displays active and available functions, countdown timer and water temperature.



LED LIGHT

Turns LED light on/off. Control the LED color. Select from seven LED colors or a slow fade color show.



PUMP/JET

Turns bath pump on/off. Control individual seats and jet groups with pre-programmed massage sequences.



BLOWER

Turns blower of/off. Choose fixed speed, wave or pulse massage. Select from six different blower massage speeds.

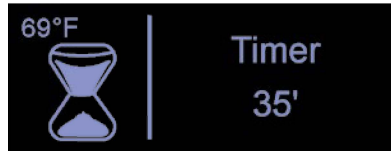

TIMER

Set a timer to automatically power down all functions..Set timers in preset increments between 5 and 60 minutes.



PROGRAMMING

Select from 27 pre-set programs and set available features. Each control head is individually programmable.

ORDERING GUIDE

CMP P/N	DESCRIPTION	BEZEL
NEXXUS LCD SERIES: FOUR BUTTON		
26413-100-110	FOUR BUTTON LCD CONTROL HEAD	WHITE
26413-102-100	FOUR BUTTON LCD CONTROL HEAD	CHROME

NEXXUS™ LCD: ROUND TWO BUTTON

PRODUCT FEATURES

- Capacitive Touch Keys
- Back-lit Screen & Keys
- White or Chrome Bezel Trim
- LCD Screen Operation
- 14 Pre-Programmed Configurations
- Multiple Seat Control
- Solenoid Valve Compatible
- Wave and Pulse Blower Operation



SPECIFICATIONS

FUNCTIONS	PUMP OPERATION BLOWER OPERATION LIGHT OPERATION SOLENOID OPERATION AUTOMATIC TIMER PURGE CYCLE
TEMP SENSOR	OPTIONAL
WATER SENSOR	2-WIRE OR 3-WIRE

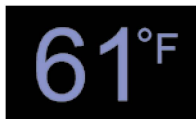

MAIN SCREEN

Displays will cycle between displaying water level and temperature.



LIGHT

Turns LED light on/off. Screen displays number of active color setting.

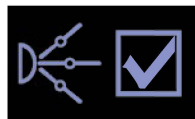

PUMP

Turns bath pump on/off. Display shows selection if pump is activated.



BLOWER

Cycle through six blower speed settings.



WAVE/PULSE

Select wave or pulse mode for blower settings.



TIMER

Set a timer to automatically power down all functions. Set timers in preset increments between 5 and 60 minutes.



JETS

Activate programmed jets using solenoid functions. Cycle between four different jet patterns.



PROGRAMMING

Select from 14 pre-set programs and set available features. Each control head is individually programmable.

ORDERING GUIDE

CMP P/N	DESCRIPTION	BEZEL
NEXXUS LCD SERIES: FOUR BUTTON		
26410-000-110	TWO BUTTON ROUND LCD CONTROL HEAD	WHITE
26410-002-100	TWO BUTTON ROUND LCD CONTROL HEAD	CHROME

PRODUCT FEATURES

- Capacitive Touch Keys
- Back-lit Keys
- White or Chrome Bezel Trim



POWER

Turn Control On/Off



PUMP

Turn Pump On/Off



BLOWER

Activate Blower & Cycle Speed



WAVE/PULSE

Activate Wave & Pulse Modes



MINUS

Decrease Blower Speed



PLUS

Increase Blower Speed



LIGHT

Activate Light & Cycle Colors



LOCK

Locks Control Function Keys

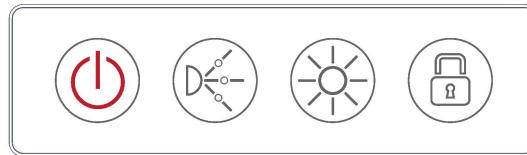
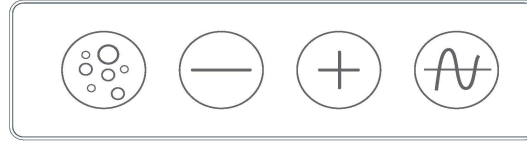
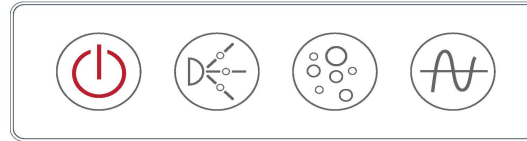
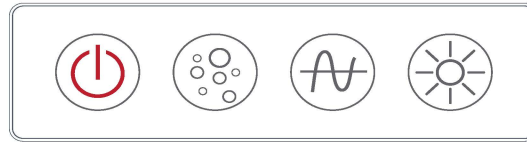
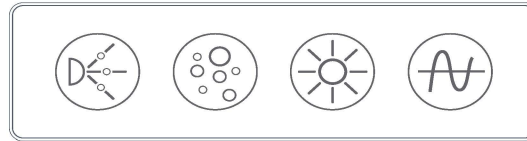
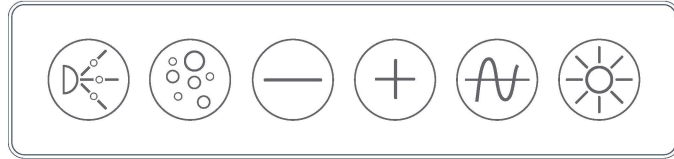

SPECIFICATIONS

AVAILABLE FUNCTIONS

PUMP OPERATION
BLOWER OPERATION
WAVE/PULSE MODES
BLOWER PLUS/MINUS
LIGHT OPERATION
CONTROL LOCK
PURGE CYCLE

WATER SENSOR

2-WIRE OR 3-WIRE

ORDERING GUIDE

WHITE BEZEL	CHROME BEZEL							DESCRIPTION
NEXXUS TOUCH SERIES								
26404-100-110	26404-102-100		✓	✓	✓	✓		SIX BUTTON CONTROL HEAD
26400-100-112	26400-102-102		✓	✓	✓		✓	FOUR BUTTON CONTROL HEAD
26400-100-114	26400-102-104	✓		✓	✓		✓	FOUR BUTTON CONTROL HEAD
26400-100-111	26400-102-101	✓	✓		✓		✓	FOUR BUTTON CONTROL HEAD
26400-100-113	26400-102-103				✓	✓	✓	FOUR BUTTON CONTROL HEAD
26400-100-110	26400-102-100	✓	✓	✓			✓	FOUR BUTTON CONTROL HEAD

NEXXUS™ TOUCH SERIES: ROUND

PRODUCT FEATURES

- Capacitive Touch Keys
- Back-lit Keys
- White or Chrome Bezel Trim



POWER
Turn On/Off



PUMP
Turn Pump On/Off



LIGHT
Activate Light & Cycle Colors

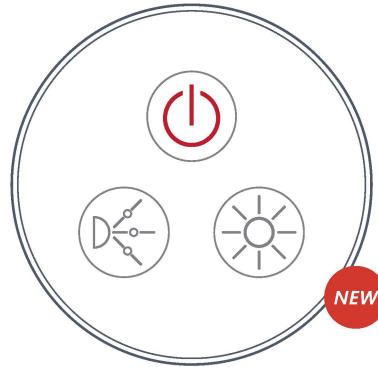

SPECIFICATIONS

AVAILABLE FUNCTIONS	PUMP OPERATION LIGHT OPERATION
WATER SENSOR	2-WIRE OR 3-WIRE

ORDERING GUIDE

WHITE BEZEL	CHROME BEZEL				DESCRIPTION
NEXXUS TOUCH SERIES: ROUND					
—	26406-002-101	✓			SINGLE BUTTON ROUND CONTROL HEAD
26406-000-103	26406-002-103	✓	✓	✓	THREE BUTTON ROUND CONTROL HEAD



NEXXUS™ LED LIGHT

NEW

PRODUCT FEATURES

- Clean, Modern Design
- Seven LED Colors & One Light Show
- Bright, Efficient LED Light
- White or Chrome Trim Ring
- Prismatic Lens Texture
- Power Cycle Color Change

SPECIFICATIONS

LIGHT COLORS	WHITE
	LIGHT BLUE
	YELLOW
	GREEN
	PURPLE
	DARK BLUE
	RED
3- SECOND COLOR CYCLE	
VOLTAGE	12 VOLT DC
TRIM COLOR	CHROME OR WHITE

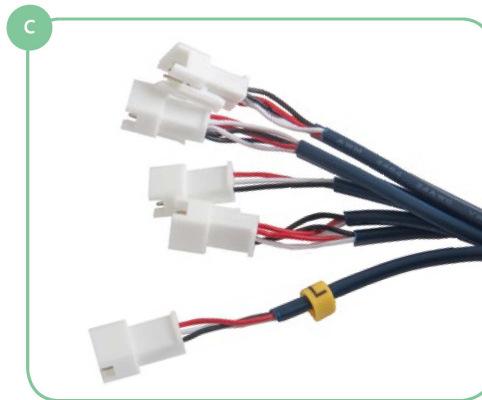
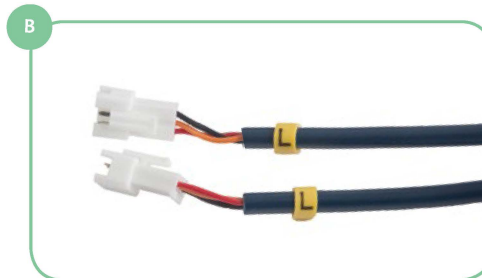

ORDERING GUIDE

REF	CMP P/N	DESCRIPTION	VOLTAGE
NEXXUS LED LIGHT			
A	26400-002-000	NEXXUS LED LIGHT, CHROME TRIM	12VDC
A	26400-000-000	NEXXUS LED LIGHT, WHITE TRIM	12VDC
B	26400-900-301	3-WIRE EXTENSION CORD	12V
B	26400-900-310	10 FOOT 3-WIRE EXTENSION CORD	12V
C	26400-900-304	FOUR LED LIGHT THREE WIRE EXTENSION CORD	12V

SOLENOIDS & ACCESSORIES



SENSORS & ACCESSORIES

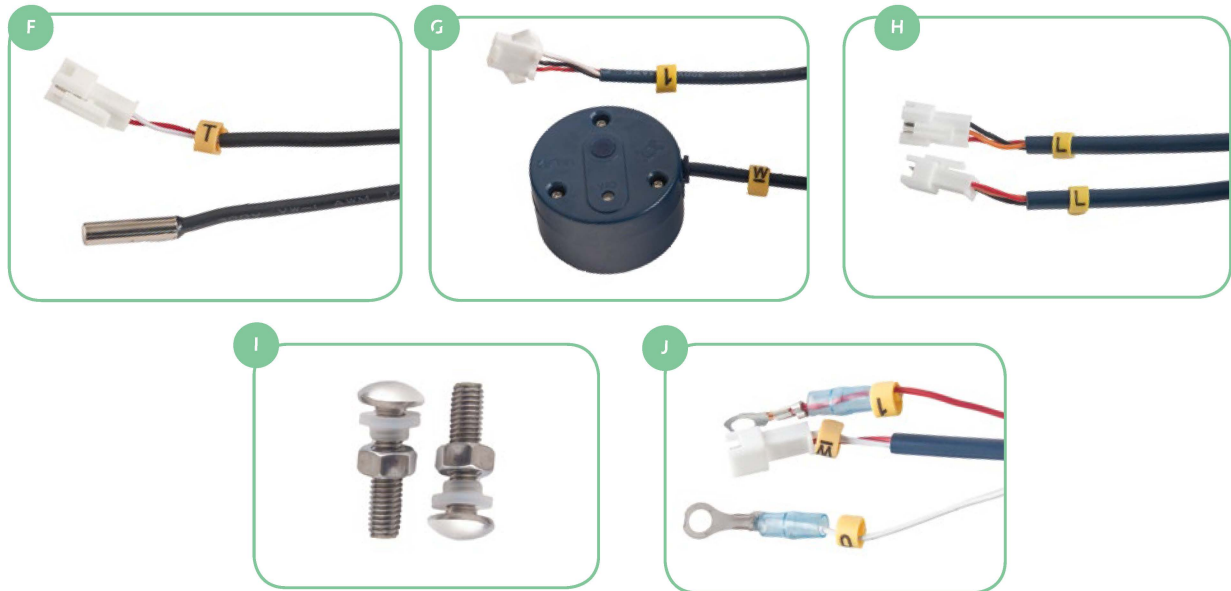

ORDERING GUIDE

REF	CMP P/N	DESCRIPTION	VOLTAGE
NEXXUS CONTROL ACCESSORIES			
A	26400-180-310	3/4IN × 3-3/8IN (180DEG) SOLENOID	12V
B	26400-180-210	3/4IN × 2-3/8IN (180DEG) SOLENOID	24V
C	26400-180-110	3/4IN × 1-3/8IN (180DEG) SOLENOID	24V
D	26400-900-006	SOLENOID JUMPER CABLE, FEMALE SPADE CONNECTORS	--
E	26400-901-202	SOLENOID EXTENSION CORD, TWO WIRE, FEMALE SPADE CONNECTORS	--
F	26400-900-000	TEMPERATURE SENSOR PROBE	--
G	26400-900-002	CAPACITIVE WATER LEVEL SENSOR	--
H	26400-900-301	3-WIRE EXTENSION CORD	--
I	26400-900-003	CONDUCTIVE WATER LEVEL SENSOR PROBE (BOLTS, NUTS, WASHERS)	--
J	26400-900-201	CONDUCTIVE WATER LEVEL SENSOR 2-WIRE CORD	--

NEXXUS™ CONTROL ACCESSORIES

NEW

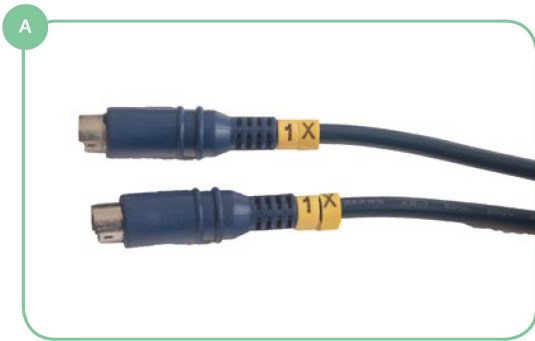

ORDERING GUIDE

REF	CMP P/N	DESCRIPTION
NEXXUS CONTROL ACCESSORIES		
A	26400-900-001	DATA EXPANSION X-CORD (MALE / MALE)
A	26400-900-010	10 FOOT X-CORD EXTENSION
B	26400-900-007	X CORD ADAPTER (FEMALE / FEMALE)
C	26400-900-900	STAINLESS STEEL CONTROL BOX BRACKET
—	26400-900-909	STAINLESS STEEL SCREW FOR CONTROL BOX BRACKET



NEXXUS™ AIR BUTTON LIGHTING CONTROL

PRODUCT FEATURES

- Air Button Control Box
- LED Light Connection
- Simplified Bath Control
- Not Compatible with Digital Control Pads
- Air Buttons Sold Separately

SPECIFICATIONS

AVAILABLE FUNCTIONS	AIR BUTTON LED LIGHT
INPUT VOLTAGE	120V AC
WATER SENSOR	N/A

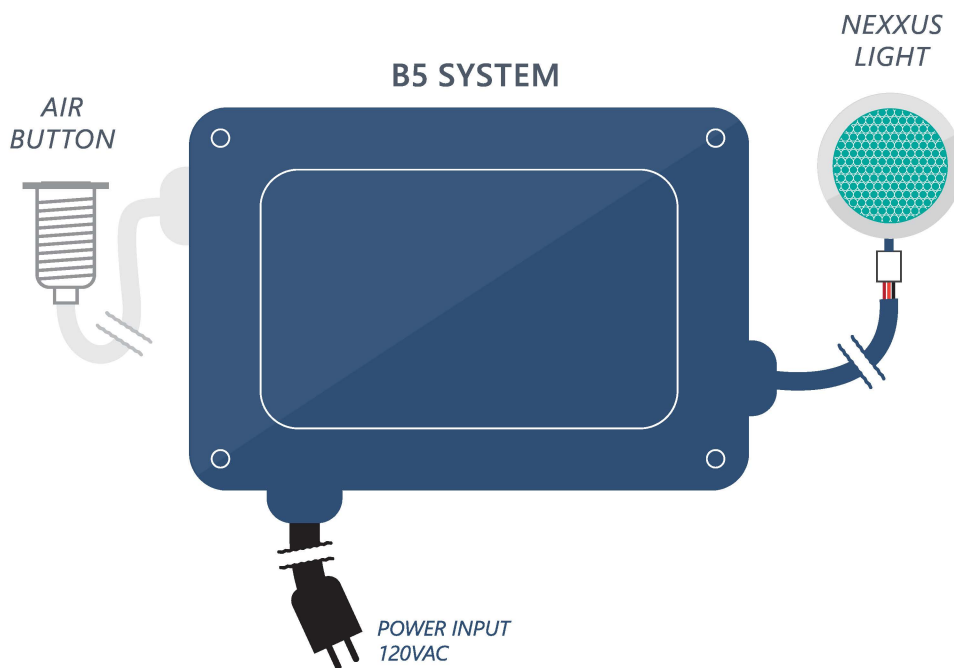
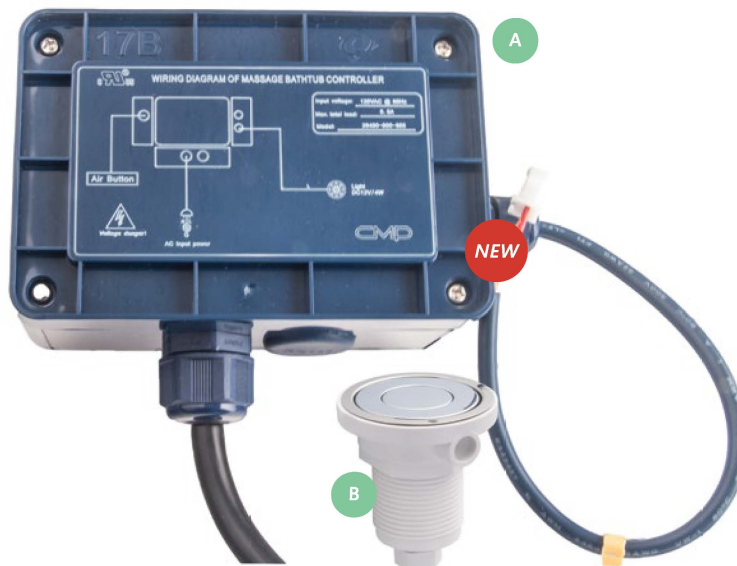

ORDERING GUIDE

REF	CMP P/N	DESCRIPTION
NEXXUS AIR BUTTON LIGHTING CONTROL		
A	26400-000-905	B5 NEXXUS AIR BUTTON CONTROL
B	—	AIR BUTTONS LISTED ON PAGE 62-63

NEXXUS™ II BATH PUMPS

Nexus II

The Nexus II Bath pump is compact, yet powerful. This quiet and efficient pump is available in two plumbing configurations.

PRODUCT FEATURES

- Locking Nut for Air Button Tubing
- Integrated Air Switch
- Thermal Protected Motor
- NEMA Plugs



110 Volt Single Speed
UL & CSA Approval

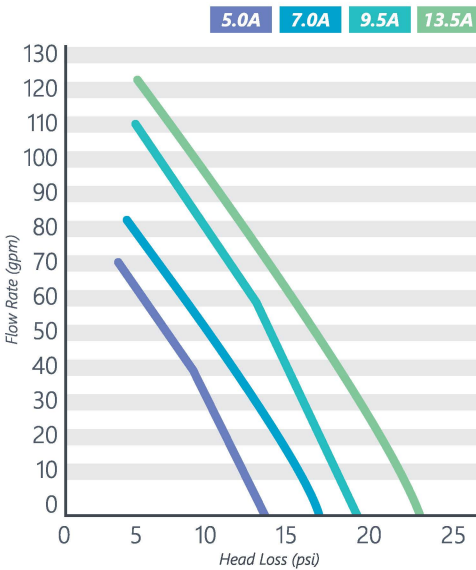

ORDERING GUIDE

REF	CMP P/N	DESCRIPTION	MAX FLOW	BOX QTY
NEXXUS II BATH PUMP				
A	27213-050-000	NEXXUS II 5.0 AMP, TOP DISCHARGE	62.5 GPM	18/72
A	27213-070-000	NEXXUS II 7.0 AMP, TOP DISCHARGE	79.5 GPM	18/72
A	27213-090-000	NEXXUS II 9.0 AMP, TOP DISCHARGE	101.7 GPM	12/48
A	27213-130-000	NEXXUS II 13.0 AMP, TOP DISCHARGE	115 GPM	12/48
B	27216-050-000	NEXXUS II 5.0 AMP, FRONT DISCHARGE*	62 GPM	18/72
B	27216-070-000	NEXXUS II 7.0 AMP, FRONT DISCHARGE*	78 GPM	18/72
B	27217-090-000	NEXXUS II 9.5 AMP, FRONT DISCHARGE*	103 GPM	12/48
B	27217-130-000	NEXXUS II 13.5 AMP, FRONT DISCHARGE*	114 GPM	12/48
C	42009-200-000	MOLDED PUMP STAND ASSEMBLY	—	1
D	27265-204-000	PLASTIC PUMP STAND	—	30
E	21014-000-000	1" x 1" x 1-1/2" SPIGOT PUMP TEE	—	180
F	21021-000-000	1-1/2" PUMP UNION	—	200

*SPECIAL ORDER ITEM, CALL FOR AVAILABILITY

NEXXUS™ | BATH PUMP

Nexxus II

The Nexxus Bath pump is a space-saving, quiet, and energy efficient pump that will perfectly meet the needs of many whirlpool bath designs.

PRODUCT FEATURES

- Locking Nut for Air Button Tubing
- Integrated Air Switch
- Thermal Protected Motor
- NEMA Plugs
- IPX5 Enclosure meets European Standards



110 Volt Single Speed
UL Approval

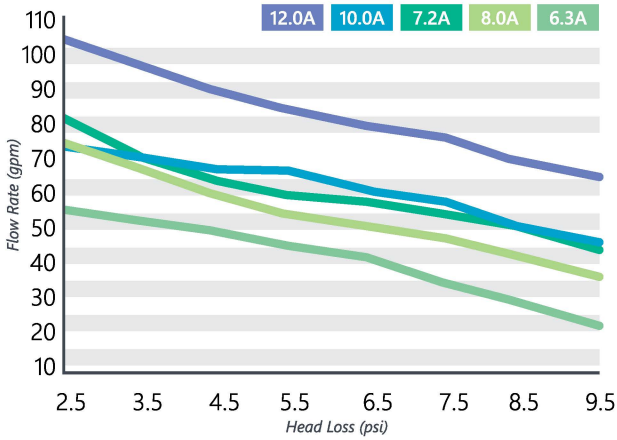

ORDERING GUIDE

REF	CMP P/N	DESCRIPTION	MAX FLOW	BOX QTY
NEXXUS BATH PUMP				
A	27210-060-000	NEXXUS 6.3 AMP	68.8 GPM	18/90
A	27210-080-000	NEXXUS 7. AMP	71.4 GPM	18/105
A	27210-090-000	NEXXUS 8.0 AMP	75.4 GPM	18/105
A	27210-110-000	NEXXUS 10.0 AMP	81.0 GPM	18/105
A	27210-130-000	NEXXUS 12.0 AMP	91.6 GPM	18/105
B	42009-200-000	MOLDED PUMP STAND ASSEMBLY	—	1
C	27265-204-000	PLASTIC PUMP STAND	—	180
D	27210-000-100	PUMP PADS (TWO REQUIRED PER PUMP)	—	180
E	21021-000-000	1-1/2" PUMP UNION	—	180
E	27239-000-900	50MM PUMP UNION	—	180

NEXXUS™ II-i BATH PUMP (WITH UNIONS)

Nexxus II-i

The Nexxus II-i with union connections is a bath pump with a variety of connection options, designed to meet international requirements.

PRODUCT FEATURES

- Locking Nut for Air Button Tubing
- Integrated Air Switch
- Thermal Protected Motor
- Includes a One Meter Cord
- IPX5 Enclosure meets European Standards



220 Volt Single Speed
CE & TUV Approval

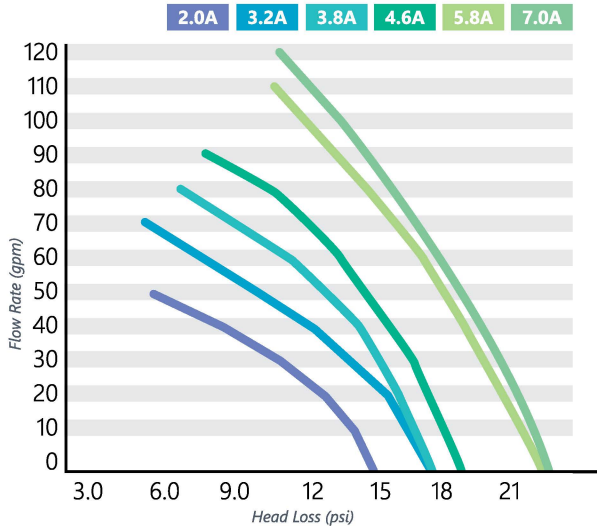

ORDERING GUIDE

REF	CMP P/N	DESCRIPTION	MAX FLOW	BOX QTY
NEXXUS II-i BATH PUMP WITH UNION CONNECTIONS				
A	27239-020-000	NEXXUS II-i 2.0 AMP	45 GPM	72
A	27239-032-000	NEXXUS II-i 3.2 AMP	65 GPM	72
A	27239-038-000	NEXXUS II-i 3.8 AMP	80 GPM	48
A	27239-046-000	NEXXUS II-i 4.6 AMP	93 GPM	48
A	27239-058-000	NEXXUS II-i 5.8 AMP	108 GPM	48
A	27239-070-000	NEXXUS II-i 7.0 AMP	118 GPM	48
B	42009-200-000	MOLDED PUMP STAND ASSEMBLY	—	1
C	27210-000-100	PUMP PADS (TWO REQUIRED PER PUMP)	—	180
D	27265-204-000	PLASTIC PUMP STAND	—	30
E	21014-000-000	1" x 1" x 1-1/2" SPIGOT PUMP TEE	—	200
F	21021-000-000	1-1/2" PUMP UNION	—	180
F	27239-000-900	50MM PUMP UNION	—	180

NEXXUS™ II-i BATH PUMP (WITH TEE)

Nexus II-i

The Nexus II-i Bath pump with Tee Outlet is a compact, quiet, and energy efficient pump designed specifically for international bath design.

PRODUCT FEATURES

- Molded Tee Outlet with 26mm Connection
- Locking Nut for Air Button Tubing
- Two Pump Pads Included with Each Pump
- Optional Air Switch
- Thermal Protected Motor
- Includes a One Meter Cord
- IPX5 Enclosure meets European Standards



220 Volt, 50Hz Single Speed
CE & TUV Approval

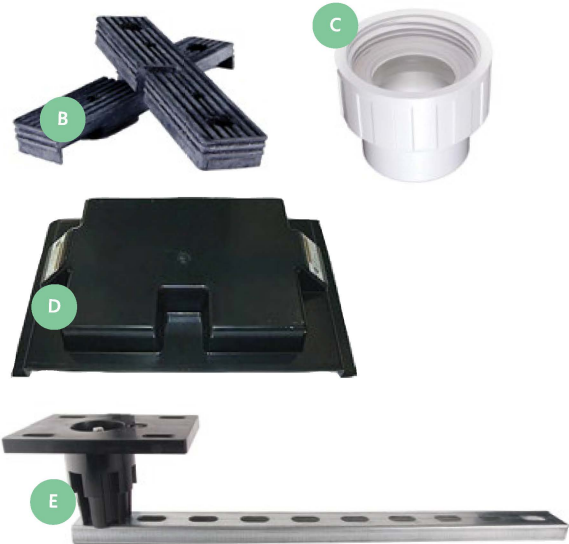
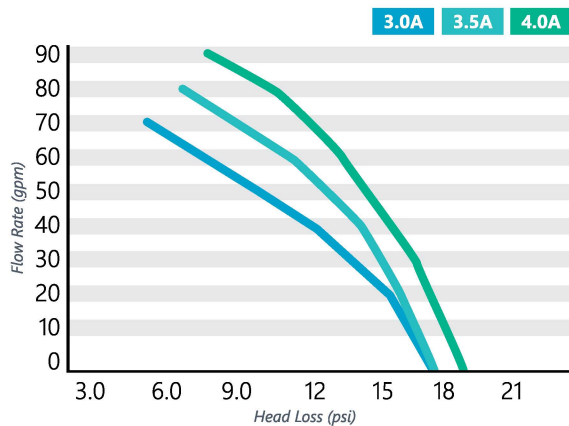

ORDERING GUIDE

REF	CMP P/N	DESCRIPTION	MAX FLOW	BOX QTY
NEXXUS II-i BATH PUMP WITH TEE DISCHARGE				
A	27239-075-000	NEXXUS II-i 3.0A, 3/4HP	60 GPM	72
A	27239-100-000	NEXXUS II-i 3.5A, 1HP	75 GPM	72
A	27239-120-000	NEXXUS II-i 4.0, 3/4HP	85 GPM	48
A	27239-075-100	NEXXUS II-i 3.0A, 3/4HP (WITH AIR SWITCH)	60 GPM	72
A	27239-100-100	NEXXUS II-i 3.5A, 1HP (WITH AIR SWITCH)	75 GPM	72
A	27239-120-100	NEXXUS II-i 4.0A, 3/4HP (WITH AIR SWITCH)	85 GPM	48
B	27210-000-100	PUMP PADS (TWO REQUIRED PER PUMP)	—	180
C	21021-000-000	1-1/2" PUMP UNION	—	180
C	21039-000-900	50MM PUMP UNION	—	180
D	27265-204-000	PLASTIC PUMP STAND	—	30
E	42009-200-000	MOLDED PUMP STAND ASSEMBLY	—	1

NEXXUS™ DH BATH HEATERS

Nexxus DH

"DURA-HEAT" ELECTRIC HEATERS

Enhance your bathing experience. The Nexxus DH electric heater helps to eliminate rapid cooling of the water temperature.

PRODUCT FEATURES

- Space Saving Compact Design
- High Limit Temp Protection
- Pressure Switch Activated
- Stainless Steel Housing
- Tee & Inline Styles



Tee: 1" Outlets, 1-1/2" Inlet
 Inline: 1-1/2 Inlet/Outlet
 UL Approval



FRICTION DISCHARGE HEATERS

An alternative to expensive electric heaters. The baffled design maximizes and creates friction heat without decreasing performance, and helps maintain water temperature.

PRODUCT FEATURES

- Safe – No Electrical Requirements
- Installs on Top of Pump Discharge Tee
- Standard Union Size for 1" Socket Outlet Connections



ORDERING GUIDE

REF	CMP P/N	DESCRIPTION	BOX QTY
NEXXUS DH HEATERS			
A	27269-150-000	120 VOLT ELECTRIC TEE HEATER, 1.5 KW	12
A	27268-320-000	220 VOLT ELECTRIC INLINE HEATER, 1.5 KW*	12
B	27268-150-000	120 VOLT ELECTRIC INLINE PRESSURE HEATER, 1.5 KW	—
B	27268-650-000	120 VOLT ELECTRIC INLINE PRESSURE HEATER, 650W	—
C	27269-009-100	FRICTION DISCHARGE MAINTENANCE HEATER	30
—	27269-009-030	OPTIONAL HEATER REDUCER (TWO REQUIRED PER HEATER)	400
—	27269-009-000	FRICTION DISCHARGE MAINTENANCE HEATER KIT	—

*SPECIAL ORDER ITEM, CALL FOR AVAILABILITY

NEXXUS™ AIR BLOWERS

Nexxus AIR

Nexxus Air blowers are compact, quiet and efficient blowers for bath. Available for U.S and International Bath requirements.

DOMESTIC (U.S) FEATURES

- Locking Nut for Air Button Tubing
- 180 Watt Heater Power
- Single Impeller Blower for US
- Integrated Air Switch for Single Speed Operation
- Variable Speed with Nexxus Bath Controls
- NEMA Cord with Plug



120 Volt, 50Hz
UL Approval



INTERNATIONAL FEATURES

- Locking Nut for Air Button Tubing
- 180 Watt Heater Power
- Double Impeller



220 Volt, 50Hz
CE, TUV Approval



ORDERING GUIDE

REF	CMP P/N	DESCRIPTION	BOX QTY
NEXXUS AIR BLOWERS			
A	27320-400-000	5.3 AMP, 120V, 50/60HZ, 400 WATT MOTOR, 180 WATT HEATER	EACH
A	27320-700-000	8.0 AMP, 120V, 50/60HZ, 700 WATT MOTOR, 180 WATT HEATER	EACH
A	27320-900-000	9.8 AMP, 120V, 50/60HZ, 900 WATT MOTOR, 180 WATT HEATER	EACH
B	27320-400-100	5.3 AMP, 220V, 50/60HZ, 400 WATT MOTOR, 180 WATT HEATER WITH OZONE*	EACH
B	27320-700-100	5.3 AMP, 220V, 50/60HZ, 700 WATT MOTOR, 180 WATT HEATER WITH OZONE*	EACH
C	27320-400-300	5.3 AMP, 220V, 50/60HZ, 400 WATT MOTOR, 180 WATT HEATER (NO OZONE)*	EACH
C	27320-700-300	5.3 AMP, 220V, 50/60HZ, 700 WATT MOTOR, 180 WATT HEATER (NO OZONE)*	EACH

*SPECIAL ORDER ITEM, CALL FOR AVAILABILITY

AIR INJECTORS

SINGLE HOLE AIR INJECTOR



LOW PROFILE AIR INJECTOR



MICRO AIR INJECTOR



ORDERING GUIDE

REF	CMP P/N	DESCRIPTION	BOX/BAG
AIR INJECTORS			
A	23036-000-000	3/8" ELL BARB AIR INJECTOR ASSEMBLY WITH 7/8" FACE*	500/50
B	23035-000-000	3/8" TEE BARB AIR INJECTOR ASSEMBLY WITH 7/8" FACE*	500/50
—	23038-010-000	AIR INJECTOR ELL BODY ONLY	1000/100
—	23037-010-000	AIR INJECTOR TEE BODY ONLY	600
—	23037-030-000	AIR INJECTOR GASKET ONLY	5000/250
C	23038-000-000	7/8" FACE 3/8" ELL BARB LOW PROFILE AIR INJECTOR ASSY & CHECK VALVE**	500/50
D	23037-000-000	7/8" FACE 3/8" TEE BARB LOW PROFILE AIR INJECTOR ASSY & CHECK VALVE **	500/50
E	23039-010-000	MICRO AIR INJECTOR ASSEMBLY, BRIGHT WHITE	500/50
E	23039-020-000	MICRO AIR INJECTOR ASSEMBLY, MEDIUM WHITE	500/50
E	23039-002-000	MICRO AIR INJECTOR ASSEMBLY, CHROME	500/50
E	23039-025-000	MICRO AIR INJECTOR ASSEMBLY, BISCUIT	500/50
—	23039-000-010	MICRO AIR INJECTOR BODY	1000/100
—	25522-256-266	MICRO AIR INJECTOR GASKET	5000/250

*NON-STOCK SPECIAL ORDER ONLY ITEM

CONTROL VALVES & BUTTONS

AIR CONTROLS & BUTTONS 62

TOP MOUNT VALVES 66

SIDE MOUNT VALVES 67

SÖL FLUSH AIR CONTROLS

SÖL Flush Air Controls are a part of the SÖL bath series featuring clean, European-influenced designs including controls, jets, suction and lighting. See the complete series on page 10.

SÖL FLUSH AIR BUTTON

PRODUCT FEATURES

- Beautiful Flush Installation
- European Inspired Modern Design
- Locking Nut for Air Button Tubing



2-11/64"/55.1mm Cap Size
1-27/32"/46.8mm Hole Size



SÖL
BATH COLLECTION

SÖL FINGERTIP AIR CONTROL

PRODUCT FEATURES

- Perfectly Flush Installation
- No Protruding Handles or Surfaces
- Fingertip Control
- Under Skirt Air Draw



2-11/64"/55.1mm Cap Size
1-27/32"/46.8mm Hole Size



SÖL
BATH COLLECTION

ORDERING GUIDE

REF	CMP P/N	DESCRIPTION	BOX/BAG
SÖL AIR BUTTON			
A	25083-800-000	FLUSH AIR BUTTON ASSEMBLY, WHITE	600/50
A	25083-802-000	FLUSH AIR BUTTON ASSEMBLY, CHROME	600/50
SÖL FINGERTIP AIR CONTROL			
B	25014-800-000	FLUSH AIR CONTROL ASSEMBLY, WHITE	400/20
B	25014-802-000	FLUSH AIR CONTROL ASSEMBLY, CHROME	400/20

AIR BUTTONS

LOW PROFILE AIR BUTTON

PRODUCT FEATURES

- Space Saving Compact Design
- Low Profile Installation
- Choice of Popular Cap Finishes



SLIM AIR BUTTON

PRODUCT FEATURES

- Locking Nut for Tubing
- CSA Approval
- Raised or Flush Button
- Choice of Popular Cap Finishes



ORDERING GUIDE

REF	CMP P/N	DESCRIPTION	BOX/BAG
LOW PROFILE AIR BUTTON			
A	25025-000-000	WHITE LOW PROFILE AIR BUTTON ASSEMBLY (PICTURED)	500/50
A	25025-002-000	POLISHED CHROME LOW PROFILE AIR BUTTON ASSEMBLY	500/50
A	25025-003-000	POLISHED BRASS LOW PROFILE AIR BUTTON ASSEMBLY	500/50
—	26204-653-820	GASKET FOR LOW PROFILE AIR BUTTON	—
B	25025-000-040	LOW PROFILE CAP & BUTTON	500/50
C	25025-000-110	LOW PROFILE BODY ASSEMBLY (BODY, NUT, BELLOWS)	500/50
SLIM AIR BUTTON			
D	25083-000-000	WHITE SLIM AIR BUTTON ASSEMBLY	600/50
D	25083-002-000	POLISHED CHROME AIR BUTTON ASSEMBLY (PICTURED)	600/50
D	25083-003-000	POLISHED BRASS AIR BUTTON ASSEMBLY	600/50
—	25083-300-000	SLIM AIR BUTTON ASSEMBLY W/ ELL BODY (BODY, GASKET, BELLOWS, CAP)	—
—	25083-100-000	COMPRESSION NUT FOR TUBING	5000
—	25083-000-041	PROTECTIVE CAP FOR SLIM CAP & BUTTON	1600
E	25083-000-040	SLIM CAP & BUTTON	600/50
F	25083-200-000	SLIM AIR BUTTON WITH SLIM CAP AND RAISED BUTTON ASSEMBLY	600/50
F	25083-200-040	SLIM CAP AND RAISED BUTTON	600/50
G	25083-000-110	SLIM BODY ASSEMBLY (NUT, GASKET, BELLOWS)	600/50
H	25083-300-100	SLIM L BODY NO CAP ASSEMBLY WITH 90DEG BARB (NUT, GASKET, BELLOWS)	—
I	25014-050-000	GASKET FOR SLIM AIR BUTTON	600/50
J	25040-019-050	LOOP ADAPTER (OPTIONAL)	—

AIR CONTROLS

UNDER SKIRT DRAW AIR CONTROL

PRODUCT FEATURES

- Space Saving Compact Design
- Under Skirt Draw

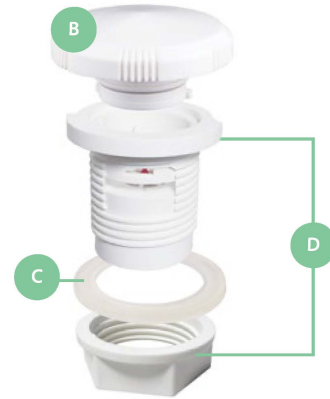
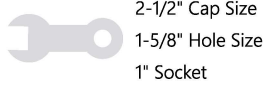

UNDER SKIRT DRAW SLIM AIR CONTROL

PRODUCT FEATURES

- White or Polished Chrome
- Side Mount Control Available
- Low Profile Control Knob

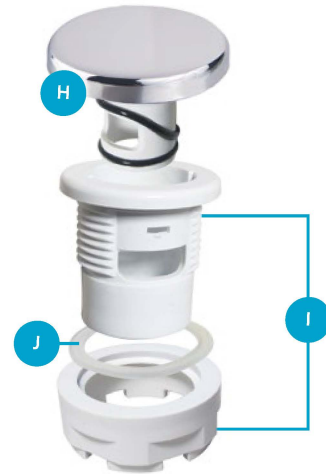

ORDERING GUIDE

REF	CMP P/N	DESCRIPTION	BOX/BAG
UNDER SKIRT DRAW AIR CONTROL			
A	25024-000-000	WHITE UNDER SKIRT AIR CONTROL ASSEMBLY (PICTURED)	250/25
A	25024-002-000*	POLISHED CHROME UNDER SKIRT AIR CONTROL ASSEMBLY	250/25
A	25024-003-000*	POLISHED BRASS UNDER SKIRT AIR CONTROL ASSEMBLY	250/25
A	25024-000-132*	STAINLESS STEEL CAP, CHROME FINISH UNDER SKIRT AIR CONTROL	250/25
A	25024-000-133*	STAINLESS STEEL CAP, BRASS FINISH UNDER SKIRT AIR CONTROL	250/25
B	25024-000-100	CAP FOR UNDER SKIRT AIR DRAW CONTROL	400/20
C	25024-000-200	BODY & NUT FOR UNDER SKIRT AIR DRAW CONTROL	400/20
D	26205-554-230	GASKET FOR UNDER SKIRT AIR DRAW CONTROL	400/20
UNDER SKIRT DRAW SLIM AIR CONTROL			
E	25015-000-000	WHITE UNDER SKIRT SLIM AIR CONTROL ASSEMBLY	400/20
E	25015-002-000	POLISHED CHROME UNDER SKIRT AIR CONTROL ASSEMBLY (PICTURED)	400/20
F	25015-100-000	SIDE MOUNT AIR CONTROL (ELBOW SOLD SEPARATELY)	400/20
G	25013-000-300	90 DEGREE ELBOW FOR SIDE MOUNT AIR CONTROL (SOLD SEPARATELY)	400/20
H	25014-000-100	CAP FOR UNDER SKIRT DRAW AIR CONTROLS	400/20
I	25015-000-200	BODY & NUT FOR UNDER SKIRT DRAW AIR CONTROL (TOP MOUNT)	400/20
J	25014-050-000	GASKET FOR UNDER SKIRT DRAW AIR CONTROL	400/20

*NON-STOCK SPECIAL ORDER ONLY ITEM

AIR CONTROLS

TOP DRAW SLIM AIR CONTROL

PRODUCT FEATURES

- White or Polished Chrome
- Slim Cap Design

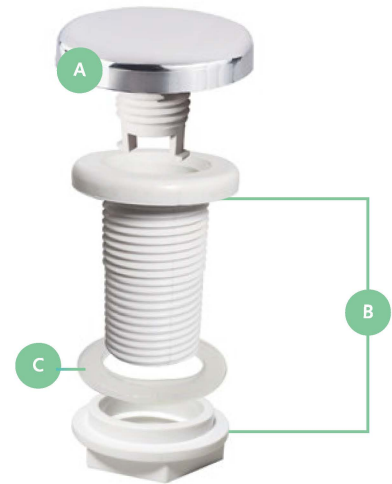
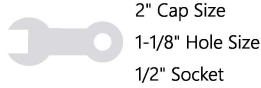

LOW PROFILE AIR CONTROL

PRODUCT FEATURES

- Low Profile Install Style
- Three Color Options

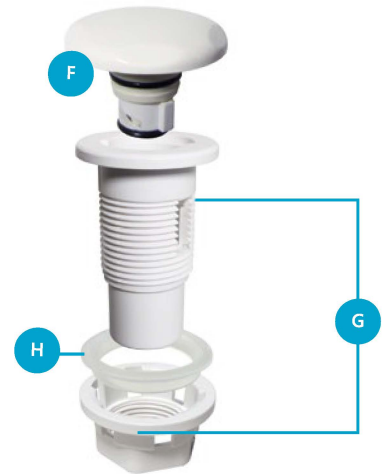
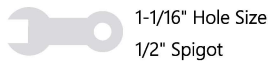

ORDERING GUIDE

REF	CMP P/N	DESCRIPTION	BOX/BAG
TOP DRAW SLIM AIR CONTROL			
A	25014-000-000	WHITE TOP DRAW AIR CONTROL ASSEMBLY	400/20
A	25014-002-000	POLISHED CHROME TOP DRAW AIR CONTROL ASSEMBLY (PICTURED)	400/20
B	25015-000-100	CAP FOR TOP DRAW AIR CONTROL	400/20
C	25014-000-200	BODY & NUT FOR TOP DRAW AIR CONTROL	400/20
D	26204-102-820	GASKET FOR TOP DRAW AIR CONTROL	400/20
LOW PROFILE AIR CONTROL			
E	25013-000-000	WHITE LOW PROFILE AIR CONTROL ASSEMBLY (PICTURED)	500
E	25013-634-500	BONE LOW PROFILE AIR CONTROL ASSEMBLY	500
E	25013-652-800	BISCUIT LOW PROFILE AIR CONTROL ASSEMBLY	500
F	25013-000-110	CAP FOR LOW PROFILE AIR CONTROL	400/20
G	25013-000-200	BODY & NUT FOR LOW PROFILE AIR CONTROL	400/20
H	25013-000-030	GASKET FOR LOW PROFILE AIR CONTROL	400/20
—	25013-000-100	90° ELBOW FOR LOW PROFILE AIR CONTROL	2000/100

1" TOP MOUNT VALVES

PRODUCT FEATURES

- 100% Shut Off Body Available for On/Off Valve
- On/Off or 3-Way Flow Control
- Low Profile Handle
- Optional Raised Handle with Larger Surface Area for Easy Adjustment

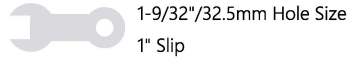

ORDERING GUIDE

REF	CMP P/N	DESCRIPTION	BOX/BAG
1" TOP MOUNT VALVES			
A	24039-100-000	1" TOP MOUNT 3-WAY DIVERTER VALVE COMPLETE ASSEMBLY (PICTURED)	50
B	24031-100-000	1" TOP MOUNT ON/OFF VALVE COMPLETE ASSEMBLY (PICTURED)	50
C	24039-100-010	SMOOTH CAP	600/50
D	24039-200-020	RAISED HANDLE CAP	600/50
E	24039-000-030	WALL FITTING FOR 1" TOP MOUNT VALVES	1200
F	24039-000-060	GASKET FOR TOP MOUNT VALVE	2000/100
G	24031-000-100	STANDARD BODY ONLY FOR 1" TOP MOUNT ON/OFF VALVE	150
G	24031-800-100	100% SHUT OFF BODY ASSY FOR 1" TM ON/OFF VALVE (W/ GASKET & WALL FITTING)	150
H	24039-000-100	1" 3-WAY BODY ONLY FOR 1" TOP MOUNT 3-WAY DIVERTER VALVE	150

1" SIDE MOUNT VALVES

PRODUCT FEATURES

- On/Off or 3-Way Flow Control
- Low Profile Handle
- Optional Raised Handle with Larger Surface Area for Easy Adjustment



1-7/32"/30.9mm Hole Size
1" Slip



ORDERING GUIDE

REF	CMP P/N	DESCRIPTION	BOX/BAG
1" SIDE MOUNT VALVES			
A	24032-100-000	1" SIDE MOUNT ON/OFF VALVE COMPLETE ASSEMBLY (PICTURED)	50
B	24038-100-000	1" SIDE MOUNT 3-WAY DIVERTER COMPLETE ASSEMBLY (PICTURED)	50
C	24039-100-010	SMOOTH CAP	600/50
D	24039-200-020	RAISED HANDLE CAP	600/50
E	24032-000-020	WALL FITTING FOR 1" SIDE MOUNT VALVES	1200
F	24039-000-060	GASKET	2000/100
G	24032-000-100	BODY ONLY FOR 1" SIDE MOUNT ON/OFF VALVE	150
E,F,G	24032-900-000	BODY ASSY FOR 1" SIDE MOUNT ON/OFF VALVE (W/ GASKET & WALL FITTING)	150
H	24038-000-100	BODY ONLY FOR 1" SIDE MOUNT 3-WAY DIVERTER VALVE	150

*FORWARD-THINKING
DESIGNS . . .
INNOVATIVE BATH
PRODUCTS*

CMP BATH
PRODUCTS

WHITE GOODS

SUCTIONS *70*

FITTINGS *74*

UNIONS & CHECK VALVES *75*

BATH MANIFOLDS *76*

FLEX HOSE & TUBING *77*

SÖL™ SAFETY SUCTION

PRODUCT FEATURES

- 110GPM Rating with Vacuum Break
- 52GPM without Vacuum Break
- Silicone Injection Ports
- IAPMO Certified
- UL Recognized
- CSA Certified



3-11/32" / 92.3mm Hole Size
1-1/2" or 50mm Slip

SÖL
BATH COLLECTION

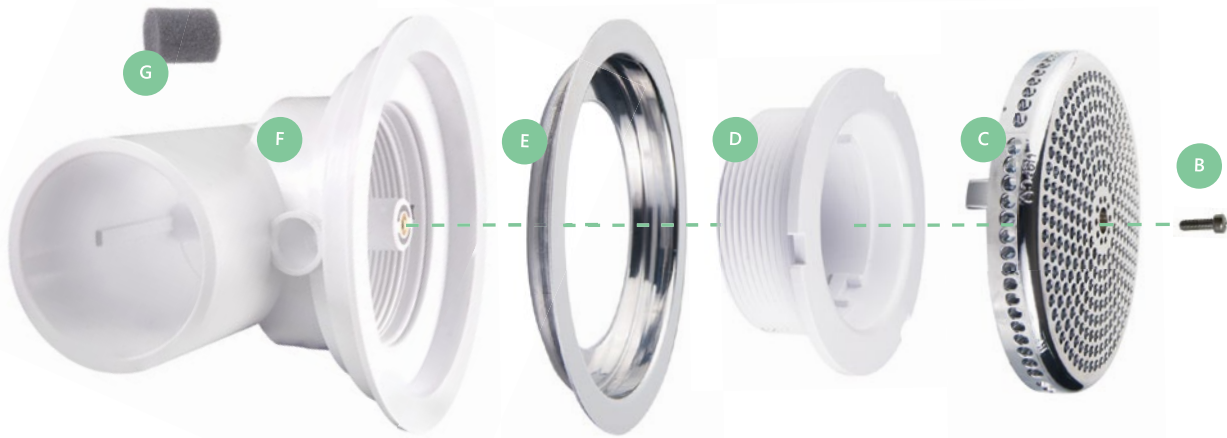

ORDERING GUIDE

REF	CMP P/N	DESCRIPTION	BOX/BAG
110GPM SOL SAFETY SUCTION			
A	25216-302-000	1.5" SLIP SÖL CLOSE-FIT FLUSH SAFETY SUCTION ASSY (PICTURED)	150
A	25216-502-000	50MM SÖL CLOSE-FIT FLUSH SAFETY SUCTION ASSY	150
B	61000-506-025	COVER SCREW	150
C	25216-000-100	SUCTION COVER	300/50
—	25216-100-100	OPTIONAL 80GPM SUCTION COVER	300/50
D	25216-200-030	CLOSE-FIT WALL FITTING	200
D	25216-000-030	110 GPM WALL FITTING	
E	25216-100-302	SS FLANGE FOR SUCTION COVER, WHITE	150
E	25216-102-302	SS FLANGE FOR SUCTION COVER, CHROME (PICTURED)	150
F	25216-250-200	1.5" SLIP CLOSE-FIT BODY WITH SPACER	100
F	25216-550-200	50MM SLIP CLOSE-FIT BODY WITH SPACER	100
F	25216-100-400	STANDARD 110 GPM SUCTION BODY WITH SPACER	
G	25202-900-000	FOAM FILTER	300
—	25216-999-999	TOOL FOR SUCTION WALL FITTING	—

150 GPM SAFETY SUCTION

PRODUCT FEATURES

- 150GMP Rating with Vacuum Break
- IAPMO Certified
- UL Recognized



ORDERING GUIDE

REF	CMP P/N	DESCRIPTION	BOX QTY
150 GPM SAFETY SUCTION			
A	25202-000-000	150 GPM SAFETY SUCTION ASSEMBLY	100
B	61000-050-012	COVER SCREW	100
C	25202-000-100	SUCTION COVER	300
D	25202-000-200	2" SLIP ELBOW FITTING	60
E	25202-000-040	COMPENSATOR RING	480
F	25202-000-030	SUCTION NUT	450
—	25202-999-999	TOOL FOR SUCTION NUT	—

110 GPM LOW PROFILE SAFETY SUCTION

PRODUCT FEATURES

- 110GPM Rating with Vacuum Break
- 52GPM without Vacuum Break
- Silicone Injection Ports
- IAPMO Certified
- UL Recognized
- CSA Certified

 2-5/8" Hole Size
1.5" Slip or 50mm

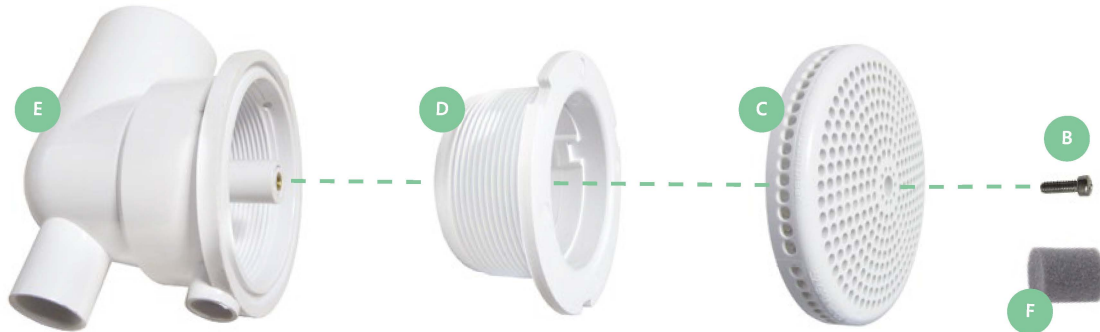

ORDERING GUIDE

REF	CMP P/N	DESCRIPTION	BOX/BAG
110 GPM LOW PROFILE SAFETY SUCTION			
A	25216-000-000	110 GPM LOW PROFILE SAFETY SUCTION ASSEMBLY	150
B	61000-506-025	COVER SCREW	150
C	25216-000-100	SUCTION COVER	300/50
—	25216-100-100	OPTIONAL 80 GPM SUCTION COVER	300/50
D	25216-000-030	WALL FITTING	100
D	25216-200-030	CLOSE FIT WALL FITTING FOR CLOSE FIT BODIES	200
E	25216-000-200	1.5" SLIP BODY	100
E	25216-200-200	1.5" SLIP CLOSE FIT BODY	100
E	25216-500-200	CLOSE FIT BODY 50MM SLIP	100
F	25202-900-000	FOAM FILTER FOR SAFETY SUCTION	300
—	25216-999-999	TOOL FOR SUCTION WALL FITTING	—

94 GPM SUCTION

PRODUCT FEATURES

- Three Variations Available
- UL Recognized

 2-5/16" Hole Size
1.5" Slip 90° Ell



ORDERING GUIDE

REF	CMP P/N	DESCRIPTION	BOX/BAG
94 GPM SUCTION WITH ELL FITTING			
A	25206-100-000	94 GPM SUCTION WITH ELL FITTING ASSEMBLY (1.5" SLIP)	100
—	25206-500-000	94 GPM SUCTION WITH EXTENDED WALL FITTING ASSEMBLY	100
B	25205-000-000	94 GPM SUCTION WITH ADAPTER ASSEMBLY (2" SPIGOT / 1.5" SLIP)	120
B	25204-001-000*	94 GPM SUCTION WITH ADAPTER ASSEMBLY (2" SLIP)	100
C	25206-000-000	94 GPM SUCTION ASSEMBLY (1-1/2" STRAIGHT SLIP)	150
D	61000-050-012	COVER SCREW	150
E	25026-000-030	SUCTION COVER	200
E	25206-000-032	STAINLESS STEEL/CHROME FINISH SUCTION COVER	150
E	25206-000-033	STAINLESS STEEL/BRASS FINISH SUCTION COVER	200
F	25206-100-200	WALL FITTING FOR ELL FITTING AND 2" ADAPTER	150
—	25026-010-200	EXTENDED WALL FITTING FOR ELL FITTING	100
G	26207-705-930	GASKET	1500/150
H	25205-070-000	1.5" SLIP ELBOW FITTING	150
I	25523-500-010	1.5" SLIP SPIGOT ADAPTER	150
D,F,H	25206-100-150	ELBOW, WALL FITTING, & SCREW KIT (NO COVER)	—
—	25206-000-200	1.5" STRAIGHT SLIP WALL FITTING	100

ELBOWS & FITTINGS



ORDERING GUIDE

REF	CMP P/N	DESCRIPTION	FITTING SIZE	BOX QTY
ELBOWS & FITTINGS				
A	21016-000-000	1" COUPLING	1" SOCKET×1" SOCKET	500
A	21015-000-000	1.5" COUPLING	1.5" SOCKET × 1.5" SOCKET	300
B	21018-000-000	1" 90° STREET ELL	1" SOCKET × 1.5" SPIGOT	500
B	21018-100-000	SHORT 1" 90° STREET ELL	1" SOCKET × 1.5" SPIGOT	500
B	21013-000-000	1.5" 90° STREET ELL	1.5" SOCKET × 1.5" SPIGOT	150
C	21008-050-000	1/2" 90° ELL	1/2" SOCKET X 1/2" SOCKET	
C	21008-000-000	2" 90° ELL	2" SOCKET × 2" SOCKET	100
C	21013-200-000	2" 90° STREET ELL	2" SOCKET × 2" SPIGOT	100
D	21105-000-000	1.5" SWEEP 90° ELL	1.5" SOCKET × 1.5" SOCKET	100
D	21005-000-000	2" SWEEP 90° ELL	2" SOCKET × 2" SOCKET (WIDE THROAT)	50
E	21020-000-000	1" 45° ELL	1" SOCKET × 1" SOCKET	500
F	21010-000-000	1.5" 45° STREET ELL	1.5" SOCKET × 1.5" SPIGOT	200
F	21010-200-000	2" 45° STREET ELL	2" SOCKET × 2" SPIGOT	100
G	21011-000-000	LEFT 1.5" 90° DRAIN ELL	1.5" SOCKET × 1.5" SPIGOT	150
G	21012-000-000	RIGHT 1.5" 90° DRAIN ELL	1.5" SOCKET × 1.5" SPIGOT	150
H	24200-200-000	26MM WYE	26MM	150
I	21009-000-000	1" LOW ANGLE WYE	1" SOCKET	200
J	21017-000-000	REDUCER TEE	1" SOCKET × 1" SOCKET × 3/4" SOCKET/1" SPIGOT	300
K	21014-000-000	PUMP TEE	1" SOCKET × 1" SOCKET × 1.5" SPIGOT	200
L	21019-000-000	1" 3-WAY ELL	1" SOCKET × 1" SOCKET × 1" SPIGOT	350
M	24202-126-000	26MM × 3/4" TEE	26MM × 26MM × 3/4" SPIGOT	

UNIONS & CHECK VALVES



ORDERING GUIDE

REF	CMP P/N	DESCRIPTION	BOX/BAG
UNIONS			
A	21045-004-000	1" SLIP PUMP UNION	250
B	21021-000-000	1.5" SLIP PUMP UNION (NUT, SLEEVE, T-GASKET)	180
B	27239-000-900	50MM SLIP PUMP UNION (NUT, SLEEVE, T-GASKET)	180
B	21021-008-000	1.5" SLIP PUMP UNION (NUT, THICK SLEEVE, T-GASKET)	180
B	21023-000-000	2" SLIP PUMP UNION (NUT, SLEEVE, O-RING)	108
C	21021-800-000	PUMP UNION TEE 26MM × 26MM × 1.5" SPIGOT	150
—	21021-030-000	T-GASKET	2500
D	21014-100-000	1" SLIP LOW PROFILE PUMP SWEEP TEE UNION	130
D	21021-900-000	1" SLIP STANDARD PUMP SWEEP TEE UNION	150
E	21047-000-000	1.5" SOCKET INLINE UNION (NUT, SLEEVE, T-GASKET, THREADED TAILPIECE)	100
F	21046-000-000	1.5" BUTTRESS × 1.5" SOCKET UNION TAILPIECE	200
G	25300-004-070	1.5" SPLIT UNION NUT & TWO SCREWS	400/50
CHECK VALVES			
H	25062-000-000	1" SOCKET SWING CHECK VALVE	120
I	25069-000-000	1.5" SOCKET UNIONIZED CHECK VALVE (1/4 LB SPRING)	112
I	25069-100-000	1.5" SOCKET UNIONIZED CHECK VALVE (3/32 LB SPRING)	75
J	25067-000-000	1.5" SOCKET/2" SPIGOT AIR CHECK VALVE (1/4 LB SPRING)	100
K	25070-000-100	1/2" SLIP POP CHECK VALVE	400
L	21064-000-000	3/8" RIBBED BARB CHECK VALVE	1000/100
L	21064-000-010	3/8" RIBBED BARB NEOPERL CHECK VALVE BODY ONLY	1000/100
M	25066-375-000	TUBING CHECK VALVE FOR 3/8" VINYL TUBE	1000/100
M	25066-275-000	TUBING CHECK VALVE FOR 3/8" VINYL TUBE (WITH SS. CHECK BALL)	1000/100
N	21064-500-000	1/2" SLIP CHECK VALVE	1000/100
O	25060-000-000	1" SLIP CHECK VALVE	600
P	27266-000-000	1" SLIP SUCTION SAFETY VALVE (2.5 LB STAINLESS STEEL SPRING)	240
P	27267-001-000	1" SLIP SUCTION SAFETY VALVE (6 LB STAINLESS STEEL SPRING)	240

MANIFOLDS & ADAPTERS

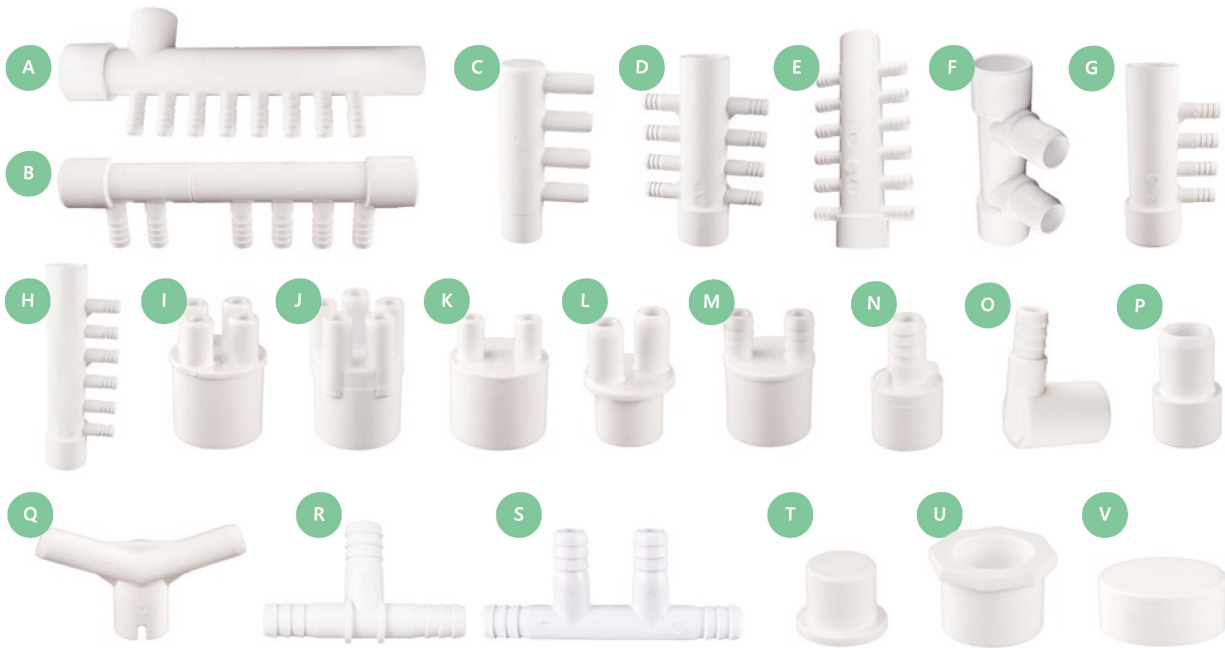

ORDERING GUIDE

REF	CMP P/N	DESCRIPTION	FITTING SIZE	BOX/BAG
MANIFOLDS & ADAPTERS				
A	21028-000-000	8 PORT 3/8" RIBBED BARB	1" SOCKET × 1" SPIGOT × 1" SPIGOT	85
B	21155-060-000	6 PORT 3/8" RIBBED BARB	1/2" SOCKET × 1/2" SOCKET	200
C	21052-100-000	4 PORT 3/8" SMOOTH BARB	1/2" SPIGOT × BLIND	500/50
D	21162-080-000	8 PORT 3/8" RIBBED BARB	1" SPIGOT × 1" SOCKET	200
E	21162-120-000	12 PORT 3/8" RIBBED BARB	1" SOCKET × 1" SOCKET	220
F	21086-000-000	2 PORT 26MM SMOOTH BARB	1" SOCKET × 1" SOCKET	100
G	21081-900-000	4 PORT 3/8" RIBBED BARB	1" SOCKET × 1" SPIGOT , TWO PLUGS & 1" CAP	250/25
G	21081-000-000	4 PORT 3/8" RIBBED BARB	1" SOCKET × 1" SPIGOT	250/25
H	21081-060-000	6 PORT 3/8" RIBBED BARB	1" SPIGOT × 1" SOCKET	200
I	21157-040-000	4 PORT 3/8" SMOOTH BARB	1" SPIGOT (PLUGS SOLD SEPARATELY)	500
I	21159-040-000	4 PORT 3/8" SMOOTH BARB	1" SLIP (TWO PLUGS)	300/20
J	21159-050-000*	5 PORT 3/8" SMOOTH BARB	1" SLIP (TWO PLUGS)	300/20
J	21080-000-000	5 PORT 3/8" SMOOTH BARB	1" SPIGOT	500/25
K	21156-020-000*	2 PORT 3/8" SMOOTH BARB	1" SLIP (TWO PLUGS)	300/20
K	21157-020-000*	2 PORT 3/8" SMOOTH BARB	1" SPIGOT (TWO PLUGS)	300/20
L	21157-520-000	2 PORT 3/8" SMOOTH BARB	1/2" SPIGOT	1200/100
M	21033-000-000	2 PORT 3/8" RIBBED BARB	1" SPIGOT	1000/50
N	21031-030-000	1/2" SPIGOT × 3/8" RIBBED BARB	1/2" SPIGOT	1000/100
O	21043-000-000	1/2" SPIGOT × 3/8" RIBBED BARB	1/2" SPIGOT	2000/100
P	24200-300-000	1" SPIGOT × 26MM SMOOTH BARB	1" SPIGOT	600
Q	21065-000-000	3/8" SMOOTH BARB WYE	USE WITH V-JET	1000/100
R	21061-050-000	3/8" RIBBED BARB TEE	3/8" × 3/8" × 3/8" RIBBED BARB	—
S	21061-300-000	3/8" 4-WAY BARB TEE	3/8" × 3/8" × 3/8" × 3/8" RIBBED BARB	—
T	21028-000-010	3/8" BARB PLUG	3/8" BARB	85
U	21131-100-010	1/2" SOCKET PLUG	1/2" SOCKET	2000/200
U	21022-000-000	1" SOCKET PLUG	1" SOCKET	500/25
U	25577-950-020	1-1/2" SOCKET PLUG	1-1/2" SOCKET	600/50
V	24200-100-000	26MM CAP	26MM	1200/100
V	21081-060-020	1" CAP	1"	1000/100

FLEX HOSE & TUBING



ORDERING GUIDE

REF	CMP P/N	DESCRIPTION	BOX/BAG
FLEX HOSE & TUBING			
A	22143-500-010	10FT AIR BUTTON TUBING, CLEAR VINYL (1/8" × 1/4")	EACH
A	22143-500-000	500FT AIR BUTTON TUBING, CLEAR VINYL (1/8" × 1/4")	EACH
B	22005-100-000	100FT FLEX HOSE (1/2")	EACH
B	22010-050-000	50FT FLEX HOSE (1")	EACH
B	22015-050-000	50FT FLEX HOSE (1-1/2")	EACH
B	22020-050-000	50FT FLEX HOSE (2")	EACH
C	22145-400-100	400FT WHITE VINYL TUBING (3/8" × 9/16")	EACH
C	22180-100-000	100FT WHITE VINYL TUBING (26MM)	EACH
D	24200-400-000	CLAMP FOR 26MM TUBING	1000
D	24375-000-000	CLAMP FOR 3/8" TUBING	5000/500



BATH ACCESSORIES

BATHTUB FEET *80*

SHOWER ACCESSORIES *81*

AROMA & CHROMATHERAPY *82*

ADA GRAB BARS & SHOWER SEATS *84*

SHOWER CURTAINS *85*

SOLID BRASS BATHTUB FEET

Classic, elegant style for bathroom decor; built for strength and durability.

PRODUCT FEATURES

- Solid Brass Feet
- Adjustable Leveling Foot
- Available in Five Popular Finishes



ORDERING GUIDE

REF	CMP P/N	DESCRIPTION	BOX QTY
SOLID BRASS BATHTUB FEET			
A	27264-202-000	POLISHED CHROME BATHTUB FEET	4
B	27264-210-000	POWDER COATED WHITE BATHTUB FEET	4
—	27264-203-000	POLISHED BRASS BATHTUB FEET	4
—	27264-213-000*	OIL-RUBBED BRONZE BATHTUB FEET*	4
—	27264-208-000	BRUSHED NICKEL BATHTUB FEET	4

*NON-STOCK SPECIAL ORDER ONLY ITEM

SHOWER ACCESSORIES

CAULK-FREE SHOWER DRAIN

PRODUCT FEATURES

- Brass Body with Chrome Cover
- Gasket Seal, No Caulk Required
- UPC Approved
- 2" IPS Connection



SHOWER SOAP TRAY

PRODUCT FEATURES

- Includes Clear Tray & Wall Housing
- Stainless Steel or Powder Coating Housing



ORDERING GUIDE

REF	CMP P/N	DESCRIPTION	BOX QTY
SHOWER ACCESSORIES			
A	27253-002-000	SHOWER DRAIN, BRASS BODY/CHROME COVER	40
B	27254-002-000	SHOWER SOAP TRAY WITH STAINLESS STEEL WALL HOUSING	108
C	27254-102-000	SHOWER SOAP TRAY WITH POWDER COATED WHITE WALL HOUSING	108
D	27254-009-020	REPLACEMENT CLEAR SOAP TRAY	400

AROMATHERAPY

LOW PROFILE AROMA THERAPY INJECTOR

PRODUCT FEATURES

- Low Profile Installation
- Bead or Strip Dispenser Compatible
- 1" Slip × 1" Slip



SCENTED BEAD BASKETS

PRODUCT FEATURES

- Compatible with all CMP Aroma Therapy Injectors
- Nine Scent Options, or Empty Basket Available



ORDERING GUIDE

REF	CMP P/N	DESCRIPTION	BOX QTY
AROMA THERAPY			
A	24040-100-000	LOW PROFILE STRIP DISPENSER ASSEMBLY	120
B	24040-000-000	LOW PROFILE BEAD DISPENSER ASSEMBLY	120
—	24040-000-030	LOW PROFILE CAP ONLY	500
—	24040-000-100	LOW PROFILE BEAD BODY ASSEMBLY (BODY, NUT, GASKET, WALL FITTING)	100
—	24040-100-100	LOW PROFILE STRIP BODY ASSEMBLY (BODY, NUT, GASKET, WALL FITTING)	100
C	23040-110-000	AROMA THERAPY INJECTOR BASKET WITH BEADS, ORANGE	10
C	23040-120-000	AROMA THERAPY INJECTOR BASKET WITH BEADS, VANILLA	10
C	23040-140-000	AROMA THERAPY INJECTOR BASKET WITH BEADS, EUCALYPTUS	10
C	23040-400-000	AROMA THERAPY INJECTOR BASKET WITH BEADS, ROSE	10
C	23040-600-000	AROMA THERAPY INJECTOR BASKET WITH BEADS, CITRUS	10
C	23040-700-000	AROMA THERAPY INJECTOR BASKET WITH BEADS, COOL MINT	10
C	23040-900-000	AROMA THERAPY INJECTOR BASKET WITH BEADS, MELON	10
C	23040-130-000	AROMA THERAPY INJECTOR BASKET WITH BEADS, WILD BERRY	10
C	23040-800-000	AROMA THERAPY INJECTOR BASKET WITH BEADS, LAVENDER	10
C	23040-000-020	AROMA THERAPY INJECTOR BASKET (NO BEADS)	10

CHROMATHERAPY

Light fittings for LEDs spots and light fixtures available in modern and traditional styles. For a complete LED light, see the Nexxus LED Light on page 50.

SÖL BATH LIGHT

PRODUCT FEATURES

- 304 Stainless Steel Trim
- Flush Installation
- Complements other SÖL Products



SÖL
BATH COLLECTION

See the complete
SÖL series on page 70

3" BATH LIGHT



2-1/2" Hole Size
Rear Access



LIGHT ACCESSORIES

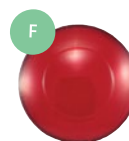
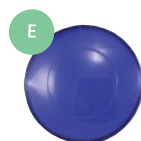

ORDERING GUIDE

REF	CMP P/N	DESCRIPTION	BOX QTY
CHROMATHERAPY			
A	25234-000-000	SÖL FLUSH LED LIGHT CLEAR LENS	100
A	25234-002-005	SÖL FLUSH LED LIGHT CHROME RING	100
A	25234-000-003	SÖL FLUSH LED LIGHT WASHER	100
A	25234-000-002	SÖL FLUSH LED LIGHT NUT	100
D	25241-000-000	3" LIGHT KIT (LENS, NUT, GASKET, REFLECTOR HOUSING)	100
—	25241-000-100	LENS, GASKET, & NUT FOR 3" LIGHT	100
—	25241-000-050	3" REFLECTOR HOUSING ONLY	100
E,F	25241-000-160	3" RED & BLUE LENS COVER KIT	100
H	25239-000-000	LIGHT BULB, GE 912	10
I	25241-000-300	BATH LIGHT WIRE HARNESS WITH AMP CONNECTOR	100
—	26400-000-000	LED LAMP WITH WHITE TRIM RING FOR NEXXUS CONTROLS (SEE PG 50)	—
—	26400-002-000	LED LAMP WITH CHROME TRIM RING FOR NEXXUS CONTROLS (SEE PG 50)	—
—	25241-000-200	BATH LIGHT WIRE HARNESS "PIGTAIL" ONLY	600
—	25241-000-500	MOLEX CONNECTOR	200
—	25242-000-000	5" LIGHT KIT (LENS, NUT, GASKET, REFLECTOR HOUSING)	50
—	25242-002-000	5" LIGHT KIT, STAINLESS STEEL (LENS, NUT, GASKET, REFLECTOR HOUSING)	50
—	25242-000-061	5" RED & BLUE LENS COVER KIT	250/25
—	25242-006-101	5" RED LIGHT LENS COVER	50
—	25242-007-101	5" BLUE LIGHT LENS COVER	50
—	25242-009-101	5" GREEN LIGHT LENS COVER	50

ADA GRAB BARS & SHOWER SEATS

SHOWER SEATS

PRODUCT FEATURES

- White Cushion Seat
- "L" Seat or Bench Style
- Right or Left Configuration Available
- White or Wood Grain Phenolic*



ADA GRAB BARS

PRODUCT FEATURES

- 304 Stainless Steel Grab Bars
- Satin Stainless or White Powder Coated
- 1-1/2" Diameter Concealed Screws
- Bulk Packaging 2,4, or 5 each Depending on Size/Shape
- Straight, "L" Shape, or "U" Shape Available



ORDERING GUIDE

REF	CMP P/N	DESCRIPTION	BOX QTY
ADA GRAB BARS & SHOWER SEATS			
A	27250-210-000	RIGHT HAND "L" SEAT, 27" x 22-1/2"	1
A	27250-110-000	LEFT HAND "L" SEAT, 27" x 22-1/2"	1
A	27250-200-000	RIGHT HAND "L" SEAT, 32" x 22-1/2"	1
A	27250-100-000	LEFT HAND "L" SEAT, 32" x 22-1/2"	1
—	27250-000-000	BENCH SEAT, 18" x 15"	1
B	27251-XXX-XXX	GRAB BARS - CONTACT CMP FOR COMPLETE LIST OF SIZES AND SHAPES	—
C	27251-100-000	OPTIONAL THREADED FLANGE FOR GRAB BARS	400

*NON-STOCK SPECIAL ORDER ONLY ITEM

SHOWER RODS & CURTAINS

PRODUCT FEATURES

- Heavy Duty PVC Material Curtains
- Anti-Bacterial Additive in each Curtain
- Standard or Weighted* Available
- 1" OD Shower Rods with Two Flanges & Four Screws
- **Shower Hooks & Rods are Sold Separately**



ORDERING GUIDE

REF	CMP P/N	DESCRIPTION	HOOKS REQUIRED	BOX QTY
SHOWER RODS & CURTAINS				
A	27252-360-000	36" x 72" SHOWER CURTAIN	6	24
A	27252-480-000	48" x 72" SHOWER CURTAIN	8	24
A	27252-540-000	54" x 72" SHOWER CURTAIN	10	20
A	27252-720-000	72" x 72" SHOWER CURTAIN	12	12
A	27252-720-200	72" x 72" WEIGHTED SHOWER CURTAIN*	12	12
A	27252-480-200	48" x 72" WEIGHTED SHOWER CURTAIN*	8	24
B	27252-000-000	SHOWER CURTAIN HOOK	—	100
C	27252-360-100	36" SHOWER ROD, 1" O.D..	—	20
C	27252-480-100	48" SHOWER ROD, 1" O.D.	—	20
C	27252-600-100	60" SHOWER ROD, 1" O.D.	—	20

*NON-STOCK SPECIAL ORDER ONLY ITEM



INFORMATION & REFERENCE

PART NUMBER INDEX 88

TERMS & CONDITIONS 91

LIMITED WARRANTY 92

ISO CERTIFICATION 94

PART#	PG	PART#	PG	PART#	PG	PART#	PG
21005-000-000	74	21081-900-000	76	23061-002-000	19	23422-500-000	30
21008-000-000	74	21086-000-000	76	23061-010-000	19	23422-500-100	30
21009-000-000	74	21105-000-000	74	23061-132-002	19	23422-500-500	30
21010-000-000	74	21131-100-010	76	23061-132-003	19	23422-999-999	30
21010-200-000	74	21155-060-000	76	23061-999-999	19	23432-000-010	28, 29
21011-000-000	74	21156-020-000	76	23062-000-100	26	23432-000-040	28, 29
21012-000-000	74	21157-020-000	76	23062-000-200	26	23432-000-050	28, 29
21013-000-000	74	21157-040-000	76	23062-020-000	26	23432-500-000	28
21013-200-000	74	21157-520-000	76	23062-050-000	26	23432-500-100	28
21014-000-000	54, 56	21159-040-000	76	23062-999-999	26	23432-500-500	28
21014-100-000	75	21159-050-000	76	23070-000-000	25	23432-700-000	29
21015-000-000	74	21162-080-000	76	23070-000-100	25	23432-700-100	29
21016-000-000	74	21162-120-000	76	23070-000-200	25	23432-700-500	29
21017-000-000	74	22005-100-000	77	23070-030-000	25	23432-999-999	28, 29
21018-000-000	74	22010-050-000	77	23070-130-000	25	23500-300-000	32
21018-100-000	74	22015-050-000	77	23070-200-000	25	24000-000-200	13, 14
21019-000-000	74	22020-050-000	77	23070-200-200	25	24000-000-205	22
21020-000-000	74	22143-500-000	77	23071-000-000	24	24000-000-220	13, 14
21021-000-000	54, 56	22143-500-010	77	23071-000-100	24	24000-000-225	22
21021-008-000	75	22145-400-100	77	23071-000-200	24	24000-000-300	14
21021-030-000	75	22180-100-000	77	23071-030-000	24	24000-000-305	14
21021-800-000	75	23035-000-000	60	23072-000-000	24, 25	24000-000-320	14
21021-900-000	75	23036-000-000	60	23400-400-030	33	24000-000-325	14
21022-000-000	19, 76	23037-000-000	60	23400-400-060	33	24001-000-200	15, 22
21023-000-000	75	23037-010-000	60	23400-500-000	33	24001-000-201	38
21028-000-000	76	23037-030-000	60	23400-600-000	33	24001-000-221	38
21031-030-000	76	23038-000-000	60	23400-800-010	16	24031-000-100	66
21033-000-000	76	23038-010-000	60	23400-800-030	16	24031-100-000	66
21034-600-000	33	23039-000-010	60	23400-800-100	16	24031-800-100	66
21039-000-900	57	23039-002-000	60	23400-840-040	16	24032-000-020	67
21042-600-000	33	23039-010-000	60	23400-900-000	31	24032-000-100	67
21042-900-000	33	23039-020-000	60	23400-900-030	31	24032-100-000	67
21043-000-000	76	23039-025-000	60	23400-900-050	31	24032-900-000	67
21045-004-000	75	23040-000-020	82	23400-900-060	31	24038-000-100	67
21046-000-000	75	23040-100-000	82	23400-900-080	16	24038-100-000	67
21047-000-000	75	23040-110-000	82	23400-900-100	31	24039-000-030	66
21052-100-000	76	23040-140-000	82	23400-940-040	31	24039-000-060	66, 67
21064-000-000	75	23040-400-000	82	23400-950-060	31	24039-000-100	66
21064-000-010	75	23040-600-000	82	23400-950-080	16	24039-100-000	66
21064-500-000	75	23040-700-000	82	23400-999-999	31	24039-100-010	66, 67
21065-000-000	76	23040-900-000	82	23401-900-000	31	24039-200-020	66, 67
21080-000-000	76	23061-000-000	19, 26	23401-900-100	31	24040-000-000	82
21081-000-000	76	23061-000-100	19	23422-000-010	30	24040-000-030	82
21081-060-000	76	23061-000-133	19	23422-000-040	30	24040-000-100	82
21081-060-020	76	23061-000-200	19	23422-000-050	30	24040-100-000	82

PART#	PG	PART#	PG	PART#	PG	PART#	PG
24040-100-100	82	24300-100-300	23	25014-002-000	65	25202-000-200	71
24100-000-010	15	24300-200-000	23	25014-050-000	63, 64	25202-900-000	70, 72
24100-000-040	22	24300-299-999	23	25014-800-000	62	25202-999-999	71
24100-000-052	22	24300-300-000	23	25015-000-000	64	25204-001-000*	73
24100-000-070	22	24300-799-999	23	25015-000-100	65	25205-000-000	73
24100-000-080	38	24375-000-000	77	25015-000-200	64	25205-070-000	73
24100-000-090	13, 38	24400-000-000	21	25015-002-000	64	25206-000-000	73
24100-000-094	15	24400-000-004	21	25015-100-000	64	25206-000-032	73
24100-000-100	22	24400-000-005	21	25024-000-000	64	25206-000-033	73
24100-000-200	13, 14	24400-000-006	21	25024-000-100	64	25206-000-200	73
24100-000-211	38	24400-000-007	21	25024-000-132	64	25206-100-000	73
24100-000-220	13, 14	24400-000-008	21	25024-000-133	64	25206-100-150	73
24100-000-300	22	24400-000-011	21	25024-000-200	64	25206-100-200	73
24100-000-400	22	24400-100-000	21	25024-002-000	64	25206-500-000	73
24100-000-500	22	24400-999-999	21	25024-003-000	64	25216-000-000	72
24100-000-600	12	24401-100-000	21	25025-000-000	63	25216-000-030	70, 72
24100-000-603	12	24500-900-000	32	25025-000-110	63	25216-000-100	70, 72
24100-000-700	12	24500-999-999	32	25025-002-000	63	25216-000-200	72
24100-000-800	22	24510-900-000	32	25025-003-000	63	25216-100-100	70, 72
24100-000-900	13	24522-000-000	32	25026-000-030	73	25216-100-302	70
24100-000-910	13	24530-000-000	32	25040-019-050	63	25216-100-400	70
24100-000-999	38	24600-000-000	17	25060-000-000	75	25216-102-302	70
24100-002-603	12	24600-000-010	11, 17	25062-000-000	75	25216-200-030	70, 72
24100-002-700	12	24600-000-020	11, 17	25066-275-000	75	25216-200-200	72
24100-012-600	12	24600-000-030	17	25066-375-000	75	25216-250-200	70
24100-100-100	22	24600-000-040	17	25067-000-000	75	25216-300-000	70
24100-500-000	14	24600-000-100	17	25069-000-000	75	25216-500-000	70
24100-500-030	14	24600-000-200	11	25069-100-000	75	25216-500-200	72
24100-500-040	14	24600-399-999	17	25070-000-100	75	25216-550-200	70
24100-500-070	14	24600-999-999	17	25083-000-000	63	25216-999-999	72
24100-500-100	14	24601-000-001	11	25083-000-040	63	25234-000-000	83
24100-900-000	22, 25	24601-002-000	11	25083-000-041	63	25234-000-002	83
24100-999-999	14, 22	24601-002-030	11	25083-000-110	63	25234-000-003	83
24101-000-200	15, 22	24601-002-040	11	25083-002-000	63	25234-002-005	83
24101-000-220	12, 15	25013-000-000	65	25083-003-000	63	25239-000-000	83
24101-000-221	38	25013-000-030	65	25083-100-000	63	25241-000-000	83
24101-000-600	12	25013-000-100	65	25083-200-000	63	25241-000-050	83
24200-100-000	76	25013-000-110	65	25083-200-040	63	25241-000-100	83
24200-200-000	74	25013-000-200	65	25083-300-100	63	25241-000-160	83
24200-300-000	76	25013-000-300	64	25083-800-000	62	25241-000-200	83
24200-400-000	77	25013-634-500	65	25083-802-000	62	25241-000-300	83
24300-000-070	23	25013-652-800	65	25202-000-000	71	25241-000-500	83
24300-100-000	23	25014-000-000	65	25202-000-030	71	25242-000-000	83
24300-100-100	23	25014-000-100	64	25202-000-040	71	25242-000-061	83
24300-100-200	23	25014-000-200	65	25202-000-100	71	25242-002-000	83

PART#	PG	PART#	PG	PART#	PG	PART#	PG
25242-006-101	83	26400-900-909	52	27250-210-000	84	27270-999-999	18
25242-007-101	83	26400-901-202	51	27251-100-000	84	27272-300-100	20
25242-009-101	83	26404-100-110	48	27252-000-000	85	27272-300-120	20
25300-000-070	75	26404-102-100	48	27252-360-000	85	27272-300-200	20
25522-256-266	60	26406-000-103	49	27252-360-100	85	27320-400-000	59
25523-500-010	73	26406-002-101	49	27252-480-000	85	27320-400-100	59
25577-950-020	76	26406-002-103	49	27252-480-100	85	27320-700-000	59
26200-230-601	19	26410-002-100	47	27252-480-200	85	27320-700-100	59
26203-202-215	33	26410-002-110	47	27252-540-000	85	27320-900-000	59
26204-102-820	65	26413-100-110	46	27252-600-100	85	42009-200-000	56
26204-653-820	63	26413-102-100	46	27252-720-000	85	42009-200-100	55, 57
26205-554-230	26, 64	27112-000-000	19	27252-720-200	85	61000-050-012	71, 73
26205-804-330	24, 25	27210-000-100	55, 56	27253-002-000	81	61000-506-005	70
26207-705-930	73	27210-060-000	55	27254-002-000	81	61000-506-025	72
26400-000-000	50, 83	27210-080-000	55	27254-009-020	81		
26400-000-901	45	27210-090-000	55	27254-102-000	81		
26400-000-902	45	27210-110-000	55	27264-202-000	80		
26400-000-904	45	27210-130-000	55	27264-203-000	80		
26400-000-905	53	27213-050-000	54	27264-208-000	80		
26400-000-906	45	27213-070-000	54	27264-213-000	80		
26400-002-000	50, 83	27213-090-000	54	27265-204-000	54, 56		
26400-100-110	48	27213-130-000	54	27266-000-000	75		
26400-100-111	48	27216-050-000	54	27267-001-000	75		
26400-100-112	48	27216-070-000	54	27268-150-000	58		
26400-100-113	48	27217-090-000	54	27268-320-000	58		
26400-100-114	48	27217-130-000	54	27269-009-000	58		
26400-102-100	48	27239-000-900	55, 75	27269-009-030	58		
26400-102-101	48	27239-020-000	56	27269-009-100	58		
26400-102-102	48	27239-032-000	56	27269-150-000	58		
26400-102-103	48	27239-038-000	56	27269-650-000	58		
26400-102-104	48	27239-046-000	56	27270-000-000	27		
26400-180-110	51	27239-058-000	56	27270-000-070	18		
26400-180-210	51	27239-070-000	56	27270-100-050	27		
26400-180-310	51	27239-075-000	57	27270-100-200	27		
26400-900-000	51	27239-075-100	57	27270-200-000	27		
26400-900-001	52	27239-100-000	57	27270-300-040	20		
26400-900-002	51	27239-100-100	57	27270-399-999	20		
26400-900-003	51	27239-120-000	57	27270-400-000	20		
26400-900-006	51	27239-120-100	57	27270-400-100	20		
26400-900-007	52	27240-148-000	38	27270-400-500	20		
26400-900-010	52	27240-248-000	38	27270-900-000	18		
26400-900-301	50, 51	27250-000-000	84	27270-900-050	18		
26400-900-304	50	27250-100-000	84	27270-900-060	18		
26400-900-310	50	27250-110-000	84	27270-900-100	18		
26400-900-900	52	27250-200-000	84	27270-900-999	18		

NUWHIRL SYSTEMS CORP STANDARD TERMS & CONDITIONS

The Terms & Conditions set forth below ("T&Cs"), together with the written information contained on the purchase order form to which these T&Cs are attached (such form and these T&Cs, together, the "Purchase Order") shall apply to the products ("Products") sold by NuWhirl Systems Corp ("NSC") to the Buyer, all as described in the purchase order form, the terms of which are incorporated herein by reference to create an integrated agreement. The Purchase Order supersedes any terms and conditions set forth in any document provided to NSC by Buyer. The Purchase Order constitutes the entire agreement between parties with respect to its subject matter, and it merges all prior and contemporaneous communications. It may not be modified except by a written agreement signed by NSC and Buyer.

Acceptance and Cancellation of Orders. Each order for Products is subject to acceptance in writing by a duly authorized officer of NSC; any written acknowledgment of receipt of an order shall not, in and of itself, constitute such acceptance. Orders accepted by NSC may be cancelled by Buyer only upon written consent of NSC. In the event of cancellation or other withdrawal of an order for any reason, and without limiting any other remedy which NSC may have as a result of such cancellation or other withdrawal, reasonable cancellation or restocking charges, which shall include all expenses then incurred and commitments made by NSC, shall be paid by Buyer to NSC. Special orders for items not normally stocked or including specially ordered Products are non-cancelable and non-returnable.

NSC is bound by all U.S. laws, export regulations, restrictions, trade embargoes, etc. ("U.S. Government Action"); therefore, any offer for the sale of Buyer to a non-US Buyer where sales are restricted by such U.S. Government Action, will not be valid and will be deemed not accepted without any liability whatsoever to NSC.

Price. Prices do not include sales, use, excise and similar taxes. Buyer will pay such taxes attributable to the sale of the Products covered hereby, or will provide NSC with tax exemption certificates acceptable to taxing authorities.

Any price quotations must be in writing and will automatically expire 30 calendar days from the date quoted. Verbal quotations are invalid unless confirmed in writing.

NSC reserves the right to increase the selling price of any Products ordered by Buyer but not shipped from NSC's place of business prior to an increase in NSC's cost of such Products and Buyer agrees to pay any price such increased price in according with the terms hereof.

Payment Terms. Payment in full for the Products, without offset or deduction, is due on or before 30 days after from the date of invoice. If payment is not timely received, interest will accrue at the rate of one percent (1%) per month on the unpaid balance or the maximum amount allowed by law, whichever is less. Acceptance of any partial payment shall not constitute a waiver of NSC's right to payment in full of all amounts owing from Buyer to NSC or the waiver of any other breach of the Purchase

Order. Payment will be made in U.S. dollars and in immediately available funds. NSC, without liability, reserves the right to suspend any further performance under this Agreement or otherwise assert alternative payment terms, in the event payment is not made when due or if, in NSC's sole discretion, Buyer's credit is or becomes unsatisfactory. Buyer waives any right to setoff any claims by Buyer against NSC against any payment owed to NSC.

Independent Contractor. Buyer shall conduct its business for its own account, as an independent contractor, in its own name, and not as an employee, partner or joint venturer of NSC. Buyer has no authority to enter into any agreements or arrangements on behalf of or in the name of NSC and has no authority to bind or obligate NSC.

Intellectual Property Rights. Buyer acknowledges and agrees that NSC has exclusive worldwide rights to the trademarks, trade names, trade dress, copyrights, slogans, logos, designs, patterns, specifications, research and development and other intellectual property rights used in connection with the Products, the names and/or marks "NuWhirl Systems," the names of the Products, any and all derivations of any of the foregoing and all registrations and applications for registration of the same (collectively, "Intellectual Property") which are and shall be exclusively in the name and for the benefit of NSC. Except as provided in the immediately following paragraph, Buyer shall make no use thereof at any time without NSC's prior written consent. Buyer specifically acknowledges and agrees that its use of the Intellectual Property shall not create in the Buyer any right, title or interest in the same and all use thereof shall inure to the benefit of NSC.

Use of Intellectual Property. NSC grants Buyer a limited, worldwide, terminable, non-royalty bearing license to use NSC's name, trademarks, trade dress, logos and copyrights solely in connection with Buyer's marketing, advertising and resale of Products and subject to the terms and conditions herein. All Intellectual Property used by Buyer pursuant to this license shall be approved by NSC prior to such use and used in the form approved by NSC without variation in color, size or other attributes. Exemplars of any uses of the Intellectual Property pursuant to this license shall be submitted to

NSC in writing (which maybe transmitted by electronic mail or facsimile) prior to such use and NSC shall have 5 business days to approve or disapprove such use in writing. In the event that NSC fails to so approve or disapprove such use within 5 business days of its receipt of an exemplar, such use shall be deemed approved. The license granted hereby may be revoked by NSC at any time upon written notice to Buyer and all rights granted hereby shall revert to NSC; *provided, however*, that regardless of any such revocation, Buyer shall be permitted to continue to use any printed material approved and printed prior to such revocation.

Ordering and Shipping Terms. All shipments to the continental United States and Hawaii are FOB NSC's warehouse, Corona, California title and risk of loss pass to Buyer upon NSC's putting shipment into possession of carrier. All shipments outside the continental United States and Hawaii are Ex Works (Incoterms 2010) NSC's warehouse, Corona, California. All Products will be shipped by means of transportation selected by NSC. Buyer shall have a maximum of 5 business days after the date of delivery to inspect Products and notify NSC in writing of any damage or to note any shortages or rejected Products. On or before 30 days after the timely receipt of any such written notice, NSC shall either grant Buyer a credit or refund for, or replace any shortages or damaged Products for which NSC is responsible or any properly rejected Products, all in NSC's sole discretion. Return of non-defective Products by Buyer to NSC must be authorized in advance in writing and will result in a 15% restocking and handling fee. All requests for returns and damages must be authorized and given a return authorization number. Buyer is responsible for freight on all returns. NSC may make shipments of less than the full number of Products ordered by Buyer.

NSC shall not be obligated to release orders unless all previous shipments have been paid in full. Buyer hereby grants NSC a purchase money security interest in all Products obtained by Buyer pursuant to the Purchase Order and in all products and proceeds thereof, including, without limitation, accounts receivable, contract rights, deposit accounts and cash. Buyer hereby authorizes NSC to file one or more financing statements recording such security interest and NSC shall have all rights of a secured party under the California Commercial Code or analogous statute in all relevant jurisdictions.

All scheduled or promised shipping dates are approximate and based upon availability of materials, production schedules, credit approval, and prompt receipt of all necessary information from Buyer. If shipment is delayed because of Buyer, NSC may, after reasonable notice to Buyer, store the Products at a place of NSC's choice at Buyer's sole risk and expense. NSC will not be liable for any damage, loss, fault, or expenses arising out of or related to delays in shipment or other

nonperformance of this Purchase Order due to any cause beyond NSC's control, including but not limited to a) strikes, fire, floods, disasters, riots and Acts of God, b) acts of Buyer, c) labor disruptions, d) shortages of fuel, power, materials, supplies, or transportation, d) domestic or foreign government action, or e) subcontractor or supplier delay.

Importing Expenses, Licensing & Regulations. For shipments outside the continental United States and Hawaii, Buyer is solely responsible for payment of any and all import expenses, duties, satisfaction of the respective licensing requirements, and compliance with all applicable laws, regulations and standards, which are required by any governmental authority to whose jurisdiction Buyer is subject or which has jurisdiction over the place to which Product is shipped.

Limited Warranty. NuWhirl Systems Corp. ("NuWhirl") warrants to the original purchaser that all products will be free of material defects in materials and workmanship for a period of

- Ten (10) years in the case of standard water pumps and water heaters used in residential applications;
- Five (5) years in the case of Microbubble pumps and pressure tanks used for residential applications and non-plated plastic fittings used in all applications;
- Two (2) years in the case of micrOzone used in residential applications;
- One (1) year in the case of all other products including, without limitation, air blowers, electronic controls and lights, speakers, surface heaters, plastic Microbubble assemblies, pillows, plated metal or plastic fittings used in all applications, and pumps and heaters used in commercial applications;

In each case, beginning on the date of purchase. This warranty may not be transferred or assigned to anyone other than the original purchaser.

In the event of any such defect, NuWhirl may, in its sole discretion, repair or replace the defective product or refund the purchase price thereof.

To obtain warranty service, purchaser must return product to NuWhirl during the warranty period using the most cost-effective shipping method. NuWhirl will reimburse the freight costs, on a pro rata basis, for the return of any products covered under warranty and determined by NuWhirl to be defective. Purchaser is responsible for all other costs incurred in obtaining warranty service, including, without limitation, all cost of removal and reinstallation of product. Purchaser is responsible for all freight costs for return of products not

covered by warranty or returned for reason other than warranty service.

THIS WARRANTY IS IN LIEU OF ALL OTHER WARRANTIES, EXPRESS OR IMPLIED, INCLUDING, WITHOUT LIMITATION, ANY WARRANTY OF MERCHANTABILITY OR FITNESS FOR A PARTICULAR PURPOSE.

NUWHIRL'S LIABILITY, IF ANY, WHETHER ARISING FROM BREACH OF WARRANTY, CONTRACT, NEGLIGENCE, INDEMNITY, STRICT LIABILITY OR OTHER TORT, OR OTHERWISE WITH RESPECT TO ITS PRODUCTS IS LIMITED TO AN AMOUNT NOT TO EXCEED THE PRICE OF THE PARTICULAR GOODS OR SERVICES GIVING RISE TO THE LIABILITY. IN NO EVENT SHALL NUWHIRL BE LIABLE FOR ANY INDIRECT, INCIDENTAL,

CONSEQUENTIAL OR SPECIAL DAMAGES, INCLUDING, WITHOUT LIMITATION, WATER DAMAGE TO STRUCTURES OR OTHER PROPERTY.

The foregoing warranty shall not apply to any product which:

- has been damaged by or subject to negligence, abuse, misuse, misapplication, improper installation, physical damage occurred during installation, alteration or modification, water intrusion of electronic controls, chemical corrosion including chlorine, or improper maintenance.
- has been used in a manner contrary to written instructions made available electronically or supplied by NuWhirl;
- has been altered or repaired by anyone not either an authorized representative of NuWhirl or at the direction of such a representative;
- is due to normal industry color variation;
- Goods damaged in transit (freight damage);
- has had the model identification or serial number removed, defaced or altered;
- requires repair or replacement due to wear and tear, including, without limitation, worn-out motor brushes.
- are Microbubble pressure tanks used for commercial applications;

There will be a charge for replacement or service if products are returned for any of the reasons listed above and purchaser will be responsible for freight costs.

Products, systems, components and fixtures not supplied or manufactured by NuWhirl may be installed in connection with NuWhirl products. NuWhirl makes no warranty with respect to such products, systems, components and fixtures.

NuWhirl does not perform and does not warrant the installation (including, without limitation, plumbing and electrical hookup) of NuWhirl products or any other

products, systems, components or fixtures installed in connection therewith and is not responsible and accepts no liability therefor.

NuWhirl reserves the sole authority to make any type of warranties or representations concerning NuWhirl or its products. This warranty cannot be modified except in a writing signed by an authorized officer of NuWhirl. NuWhirl will not be responsible for any warranties or representations made by any third party, including dealers, retailers, distributors, or contractors.

Claims Concerning the Products. Except for statements and claims made in written materials provided to Buyer by NSC, Buyer shall not make any statements or claims concerning any Product relating to its safety, benefits (medical or otherwise), ease of use or the use, storage, handling or disposal or operation of the Product without first obtaining the written approval of an officer of NSC. Any such statement or claim which is neither made in written materials provided to Buyer by NSC nor properly approved is referred to as an "Unapproved Claim."

Buyer's Assumption of Risk, Covenants and Indemnity. Buyer assumes all risk, liability and responsibility for any loss, damage, cost and expense arising out of or resulting from the handling, use, storage, disposal, or application of the Products. Buyer hereby assumes and agrees to indemnify, defend, and hold NSC harmless from and against all liability, loss, cost, damage, expense (including reasonable attorney's fees) arising out of or in connection with claims by Buyer, its employees, customers, independent contractors, and any third parties based upon or resulting from an Unapproved Claim or the handling, use, storage, disposal, or application of the Products. Buyer warrants that the Products shall not be resold, transferred exported or reused in any way by Buyer in violation of any U.S. Government Action. Buyer will indemnify, defend, and hold NSC harmless, including reasonable attorney fees, court costs, and costs of investigation and defense, from any harm or damages or liability caused to NSC by any breach of the foregoing representations or for the failure to comply with any laws or regulations, including without limitations, U.S. Government Action.

Limitation on Liability. Notwithstanding anything to the contrary herein, in no event shall NSC be liable for any indirect, special, incidental, consequential, exemplary or punitive damages, whether foreseeable or not, that are in any way related to this Purchase Order, the breach hereof, loss of goodwill or profits, lost business however characterized and/or from any other cause whatsoever.

Subrogation. Buyer does hereby for itself and any parties claiming under or through it, release and discharge NSC from and against all hazards covered by Buyer's or any third party's insurance or self insurance retention, and

all claims against NSC arising out of such hazards, including any right of subrogation by Buyer's or such third party's insurance carrier, are hereby waived by Buyer, and Buyer shall promptly so notify its insurance carrier.

Cause Beyond Control. The parties hereto shall not be liable for the nonperformance of any of their obligations hereunder, except nonpayment of amounts owing hereunder, if such nonperformance is occasioned by any war, government regulation or restriction of action, strike, lock out, accidents, storms, earthquakes, acts of terrorism, civil commotion, riot, fire, flood, accident, labor disputes, shortage or difficulty or inability to obtain materials for the manufacture of the Products, delay or failure in transportation or delivery, embargoes, "acts of God" or the public enemy or similar causes beyond the control of the parties hereto.

General. The Purchase Order shall be construed and controlled by the laws of the State of California, without regard to the choice or conflicts of law provisions of any jurisdiction. Buyer consents to exclusive jurisdiction and venue in the state and federal courts sitting in and for the

County of Los Angeles, California. No suit or action that relates to the Purchase Order shall be commenced more than one year after the date hereof. In the event of any action to enforce the terms of the Purchase Order the prevailing party may be awarded its reasonable attorneys fees and costs. All agreement, covenants, conditions and provisions contained herein shall apply to and bind the assignees and successors in interest of Buyer. If any provision or portion of this agreement is held to be invalid, illegal, unconscionable or unenforceable, the other provisions and portions hereof shall not be affected. The several captions used herein are for the convenience of the parties only and shall not affect the construction or the interpretation hereof

Non-Waiver. NSC's failure at any time to insist upon strict performance of any term, covenant or condition of this Purchase Order shall not be deemed a waiver of NSC's right thereafter at any time to insist upon strict performance of the said term, covenant or condition.

END OF TERMS & CONDITIONS